

Uniclass L41305/6	
CI/SfB (31.4)	Xh4

February 2012

sapa:

buildingsystem

ARCHITECTURAL ALUMINIUM SOLUTIONS

ENHANCED THERMAL INSULATION PERFORMANCE

Meets **Part L 2010**



Dualframe 75mm Si Tilt Before Turn Window and 75mm Si Casement Window

Technical Data Sheet

Dualframe 75mm Si Tilt Before Turn Window

- 03 Design Features
- 04 Performance Data
- 10 Support Services
- 11 Profiles
- 16 Profile Inertia Values
- 18 General Arrangements Cills

Dualframe 75mm Si Casement Window

- 06 Performance Data
- 08 Specifications
- 10 Support Services
- 13 Profiles
- 17 Profile Inertia Values
- 31 General Arrangements Cills

Specialist Profiles

- 45 Dualframe 75mm Si Tilt Before Turn Window
- 45 Dualframe 75mm Si Casement Window

Contemporary Design: Dualframe signifies a new era in aluminium fenestration, with products that have been specifically designed to comply with the ever increasing complexity of Building Regulations, British Standards and other regulatory demands.

Superior thermal performance: Dualframe comfortably exceeds the requirements of Part L 2010 of the Building Regulations for both thermal insulation and air permeability and has been designed to be compliant with future anticipated changes. Where required, Dualframe 75mm Si Window can achieve an “A” Window Energy Rating and ‘U’ Values down to 0.9 $\text{W/m}^2\text{K}$, also enabling a generic BREEAM ‘A’ rating to be achievable against the Green Guide for Commercial Windows.

Dual colour capability: All Dualframe products can have differing finishes internally and externally.

Integrated Design: The Dualframe Si suite consists of a high performance casement, tilt before turn and MFS, a cost effective alternative to curtain wall allowing the installation of modular units that are constructed off-site and capable of a two story span. The Si range sits alongside the well established Dualframe range which also includes casement and tilt before turn but also comprises pivot, reversible, single and double door configurations.

Unique polyamide thermal barrier With integral bead retention leg to minimise projection of opening lights.

Accreditation: Dualframe Si casement and tilt before turn windows have been awarded BSI Kitemarks to BS4873 ‘Specification for aluminium alloy windows’ and BS7950 ‘Specification for enhanced security performance of casement and tilt before turn windows for domestic applications’.

Dualframe doors have been awarded BSI PAS023-1:1999, ‘General performance requirements for door assemblies; Part 1 – single leaf door assemblies to dwellings’ and PAS024-1:1999 ‘enhanced security performance requirements for door assemblies; Part 1 – single leaf external door assemblies to dwellings’.

Dualframe Si casement, tilt before turn, reversible, Dualframe doors and Dualframe MFS meet the Secured by Design specification.

Dualframe 75 casement can achieve an ‘A’ Window Energy Rating (WER) where required.

Aesthetics: Chamfered, Softline and flat vent profiles are available to many products within the Dualframe suite, options of internal or external beading (including BS7950 compliant security) are also available.

Ease of maintenance: The integration of a ‘Eurogroove’ feature enables use of industry standard hardware, available from a variety of sources so that the product is competitive and easily maintained.

Product

Dualframe 75mm Si Tilt Before Turn Window, Dualframe 75mm Si Casement Window, Dualframe 75mm Si MFS (Modular Facade System)

Design Variants

Can be constructed to form fixed and opening lights either as combination frames or as separate coupled lights.

Compatibility

Can also be integrated with other products from the Dualframe range, Crown and Elegance 52 ranges.

Application

Suitable for installation in new build or replacement projects in residential, commercial or public buildings.

Finishes

A wide range of polyester powder coat finishes is available to BS EN 12206:1 2004. Anodised finishes are to BS3987 Grade AA25 etch silver with a range of special anodised finishes on application.

For more details, or to talk to a Project Consultant, contact the Marketing Team on 01684 853500.



BSI Registered firm
Licence No. FM0114



BS 4873
Licence No. KM74159



BS 7950
Licence No. KM74141



PAS 23-1 & PAS 24-1
Licence No. KM90215

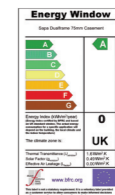

Doorsets PAS 23 & 24
Certificate Number 044



BS7950 & BS4873
Certificate Number 034



Aluminium Windows
BS 4873
Certificate Number 001



Official Police Security Initiative



ISO 14001

Materials

Aluminium profiles are extruded from aluminium alloy 6063 or 6060 T6 complying with the recommendations of BS EN 755-9:2007. Polyester powder coat finishes are available to BS EN 12206-1:2004 in a wide range of colours. Anodised finishes are to BS 3987 Grade AA25 etch silver as standard, with a range of special anodised finishes on application.

Weatherstripping is a TPE seal internally and externally, both set in undercut grooves in the sash and frame.

Construction

Frame members are square or mitre cut at 45°. Corners are reinforced with stainless steel corner ties and die cast zinc corner cleats where required. All joints shall be sealed during fabrication against water entry.

The thermal barrier section is achieved using two separate aluminium extrusions and two bespoke polamide extrusions mechanically jointed to form a single compound profile.

Integral reverse rebate units can be manufactured using the unique reverse rebate frames and adaptors, to form a glaze out fixed light, next to a tilt before turn window.

Authority

BS7950: Specification for enhanced security performance of casement and tilt/turn windows for domestic applications.

BS4873: Aluminium Alloy Windows.

BS6375-1: Performance of windows: Classification for weather tightness and guidance on selection and specification.

BS6375-2: Performance of windows. Specification for operation and strength characteristics.

BS6262: Code of practice for glazing for buildings.

BS EN 755-9: Aluminium and aluminium alloys. Extruded rod/bar, tube and profiles. Profiles, tolerances on dimensions and form.

BS3987: Specification for anodic oxide coatings on wrought aluminium for external architectural applications.

BS EN 12206:1 2004: Specification for powder organic coatings for application and stoving to aluminium alloy extrusions, sheet and perforated sections for external architectural purposes.

BS EN 10077-2: Thermal performance of windows, doors and shutters – calculation of thermal transmittance – Part 2: Numerical method for frames.

Site Work

A fabrication, installation and glazing service is available through a network of fabricators and installers. For details of suitable fabricators and installers, please contact our Marketing Team on 01684 853500.

Hardware & Security

Opening lights are hung on concealed, zinc plated steel, tilt before turn gear with locking cams and zinc plated zinc die cast keeps. Handles can be colour matched and are aluminium die castings. Handles are of the 'safety locking' type which means that the turn mode can be locked off to unauthorised users. Security keeps must be fitted when enhanced security to BS7950 is required.

Glazing

Drainage in accordance with details listed in this manual meets the requirements of "Ventilated and Drained Glazing System", as specified in BS6262. Glass must conform to BS6262 for thickness and type. Insulating glass units of 24mm, 28mm and 32mm can be accommodated.

Glass is set against extruded synthetic rubber gaskets retained in undercut grooves within the aluminium profile. Final retention of the glass is achieved by the application of a co-extruded PVCu/ synthetic rubber wedge gasket between the inner face of the glass and the bead.

Weather Performance

When tested in accordance with BS6375:Part 1:2004 all products listed in this data sheet, when manufactured, installed and glazed strictly in accordance with Sapa Building Systems' specifications, will achieve the following exposure category '2400 Special'.

Opening Lights

Water Tightness Class 9A (600 pascals)
 Permeability Class 4 (600 pascals)
 Wind Resistance Class E (2400 pascals)*

Fixed Lights

Water Tightness Class 9A (600 pascals)
 Air Permeability Class 4 (600 pascals)
 Wind Resistance Class E (2400 pascals)*

* Exposure category varies with Width/Height of window and mullion / transom used, as these are the only unsupported members. An accurate figure can be obtained using BS6399 Part 2 calculations and inertia values given on page 14.

Maximum fixed light area = 5m².

Thermal Performance

Dualframe 75mm Si can meet and surpass the area weighted average U values stipulated in Part L of the Building Regulations. Lower U-values can be achieved using double glazed units with enhanced thermal insulation, such as 'soft coat' low emissivity glass, argon gas filling and thermally broken spacer bar.

Security

When security gear is used, and the window is manufactured and glazed in accordance with the manual, the window can conform to the requirements of BS7950:1997

Size Limitations

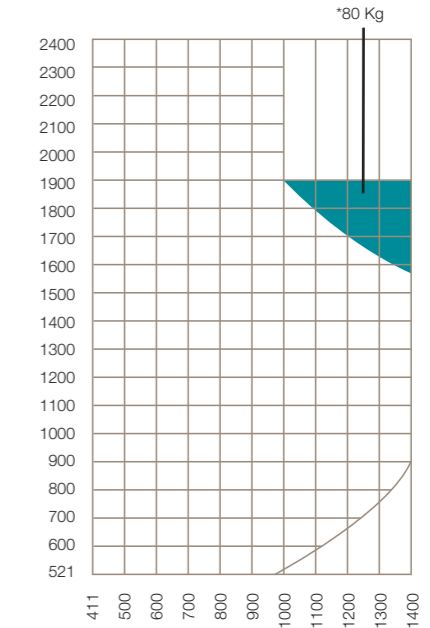

Fixed Light

Maximum area 5 sq.m

Sash Rebate

Minimum Width 411 mm
 Maximum Width 1400 mm
 Minimum Height 521 mm
 Maximum Height 2400 mm
 Maximum Sash Weight 100 kg*

Refer to matrix above for height to width ratio of opening light

*The maximum Sash Weight is reduced to 80 kg in area marked on the matrix above

Materials

Aluminium profiles are extruded from aluminium alloy 6063 or 6060 T6 complying with the recommendations of BS EN 755-9:2001. Polyester powder coat finishes are available to BS EN 12206-1:2004 in a wide range of colours. Anodised finishes are to BS 3987 Grade AA25 etch silver as standard, with a range of special anodised finishes on application.

Weatherstripping is a TPE seal internally and externally, both set in undercut grooves in the sash and frame.

Construction

Frame members are square or mitre cut at 45°. Corners are reinforced with stainless steel corner ties and die cast zinc corner cleats where required. All joints shall be sealed during fabrication against water entry.

The thermal barrier section is achieved using two separate aluminium extrusions and two bespoke polamide extrusions mechanically jointed to form a single compound profile.

Integral reverse rebate units can be manufactured using the unique reverse rebate frames and adaptors, to form a glaze out fixed light, next to a Tilt before Turn window.

Authority

BS7950: Specification for enhanced security performance of casement and tilt/turn windows for domestic applications.

BS4873: Aluminium Alloy Windows.

BS6375-1: Performance of windows: Classification for weather tightness and guidance on selection and specification.

BS6375-2: Performance of windows. Specification for operation and strength characteristics.

BS6262: Code of practice for glazing for buildings.

BS EN 755-9: Aluminium and aluminium alloys. Extruded rod/bar, tube and profiles. Profiles, tolerances on dimensions and form.

BS3987: Specification for anodic oxide coatings on wrought aluminium for external architectural applications.

BS EN 12206:1 2004: Specification for powder organic coatings for application and stoving to aluminium alloy extrusions, sheet and perforated sections for external architectural purposes.

BS EN 10077-2: Thermal performance of windows, doors and shutters – calculation of thermal transmittance – Part 2: Numerical method for frames.

Site Work

A fabrication, installation and glazing service is available through a network of fabricators and installers. For details of suitable fabricators and installers, please contact our Marketing Team on 01684 853500.

Hardware & Security

Opening lights are hung on concealed, stainless steel variable geometry friction hinges. Espagnolette locks are zinc plated steel, with zinc plated die cast keeps. Handles can be colour matched and are zinc die castings. Optional Vector Excluder hinge protectors must be fitted when enhanced security to BS7950 is required.

Glazing

Drainage in accordance with details listed in this manual meets the requirements of “Ventilated and Drained Glazing System”, as specified in BS6262. Glass must conform to BS6262 for thickness and type. Insulating glass units of 24mm, 28mm and 32mm can be accommodated.

Glass is set against co-extruded PVCu / Nitrile gaskets retained in undercut grooves within the aluminium profile. Final retention of the glass is achieved by the application of a co-extruded PVCu / Nitrile wedge gasket between the inner face of the glass and bead or frame.

Performance

When tested in accordance with BS6375:Part 1:2009 all products listed in this data sheet, when manufactured, installed and glazed strictly in accordance with Sapa Building Systems’ specifications, will achieve the following exposure category ‘2400 Special’. (see below)

Opening Lights

Water Tightness	Class 9A (600 pascals)
Permeability	Class 4 (600 pascals)
Wind Resistance	Class E (2400 pascals)*

Fixed Lights

Water Tightness	Class 9A (600 pascals)
Air Permeability	Class 3 (600 pascals)
Wind Resistance	Class E (2400 pascals)*

* Exposure category varies with Width/Height of window and mullion / transom used, as these are the only unsupported members. An accurate figure can be obtained using BS6399 Part 2 calculations and inertia values given on page 15.

Maximum fixed light area = 5m².

Thermal Performance

Dualframe 75mm Si can meet and surpass the area weighted average U values stipulated in Part L of the Building Regulations. Lower U-values can be achieved using double glazed units with enhanced thermal insulation, such as ‘soft coat’ low emissivity glass, argon gas filling and thermally broken spacer bar.

Size Limitations

Note All sizes given are in millimetres, all vent maximum and minimum sizes relate to the overall size of the vent frame and not the outerframe.

Vent frame = “B” size + 12mm (see page 4-1 for an explanation of “B” size)

Fixed Light

Maximum area 5 sq.m

Standard Casement Side Hung

Stay Size	8"	12"	16"
Max Width	440	640	740
Max Height	1200	1300	1300
Max Weight	18kg	22kg	24kg
Min Width	250	351	453
Min Height	424	424	424

Top Hung

Size	6"	8"	10"	12"	16"	20"	24"
Max Width	1200	1200	1200	1200	1200	1200	1200
Max Height	340	390	440	590	820	1140	1340
Max Weight	10kg	12kg	16kg	20kg	21kg	26kg	40kg
Min Width	424	424	424	424	424	424	424
Min Height	199	249	315	390	540	740	890

Heavy Duty Casement Side Hung

Stay Size	10"	16"
Max Width	706	884
Max Height	1524	1829
Max Weight	38kg	47kg
Min Width	303	496
Min Height	424	424

Top Hung

Super Heavy Duty

Stay Size	10"	12"	16"	22"	22"
Max Width	1600	1600	1600	1600	1539
Max Height	681	883	1136	1500	1750
Max Weight	37kg	45kg	55kg	75kg	100kg
Min Width	424	424	424	424	541
Min Height	313	681	883	1136	1095

Project Consultancy

Our field based Project Consultants, working with our in-house Contracts Design and Administration team, provide UK specifiers with specialist advice concerning the correct application of products, giving guidance on Building Regulations, British Standards and other issues such as product specifications, usage, maintenance and safety. Complementary to this, our Product Support Department has an invaluable reservoir of experience on every aspect of our product range.

Specification Process

We also appreciate that the specification process is influenced by client demands to obtain best value, and to that end, we can participate in site visits, design meetings and budgetary planning. Design stages can be formalised through written specification documents (which can be supplied in either an NBS format, or your own specification layout) and supported by samples, literature and drawings for consultation or planning issues.

Partnership Approach











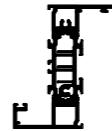
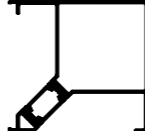





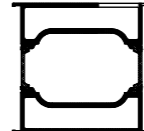

Taking this partnership approach through the whole project allows on-site monitoring of manufacturing and installation ensuring the specifier always has professional support from a worldwide group. Drawing on one of the largest fabricator and installer networks in the UK, we can provide details of specialist contractors who will quote or tender competitively for any type of contract.

Sapa Group

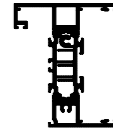







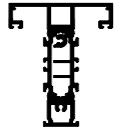
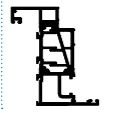
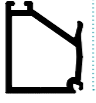
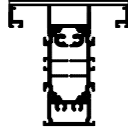

Sapa Building Systems Limited is a member of the worldwide Sapa Group. We develop and market high value-added profiles in aluminium and are the leading independent producer of aluminium profiles in the world, with customers in Europe, North America and Asia. In the UK, Sapa Group has extensive multisite extruding, re-melt, anodising and polyester powder coating facilities, offering total control and a fast and co-operative response.

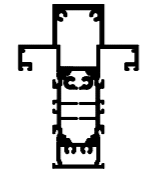
Backed by the resources of the Group, Sapa Building Systems Limited offers architects and specifiers a wide range of innovative aluminium systems for curtain walling, doors, windows and specialist applications. With a wealth of European knowledge and experience we have the product range and service that incorporates the highly respected brands that have satisfied the demands of specifiers for over four decades. Our company systems have been approved under BS EN ISO 9001:2000 and we are recognised as an Investor in People.

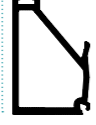
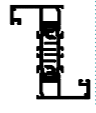
[For specification assistance or details of fabricators & installers, please call our Marketing Team on 01684 853500.](#)

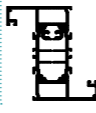
Illustration	Part No.	Description	Illustration	Part No.	Description	Illustration	Part No.	Description						
Outerframe Profiles														
	DF1400	Square Outerframe		DF1408	Unequal Leg Square Outer Open Cut		UF500	90° Corner Post						
	DF1401	Square Outerframe Extended		DF1409	21mm Universal Outerframe		UF500-A	External - 90° Corner Post						
	DF1402	HD Facade Frame		DF1410	31mm Universal Outerframe		UF500-B	Internal - 90° Corner Post						
	DF1403	Facade Frame	Couplers & Misc Profiles							UF503	75mm Heavy Duty Coupler			
	DF1404	Unequal Leg Square Outerframe Open In								DF047	Reverse Rebate Adaptor		UF504	25mm Heavy Duty Coupler
	DF1407	Square Outerframe Extended Leg								DF072	25mm Coupler		UF505	50mm Heavy Duty Coupler
				DF073	Coupler		UF508	Trickle Vent Body						
				16323	Face Applied Dummy Mullion/Transom									

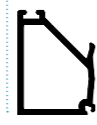
Profiles Dualframe 75mm Si Tilt Before Turn Windows

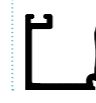
Illustration	Part No.	Description	Illustration	Part No.	Description	Illustration	Part No.	Description
Mullion & Transom Profiles								
	DF1420	Mullion/Transom Flat 63mm		DF1430	TBT Vent Glaze In		DF045	32mm TBT Vent Glazing Bead
	DF1421	Wide Mullion/Transom Flat 73mm	Cill Profiles				DF046	32mm Outerframe Glazing Bead
	DF1422	Heavy Duty Mullion/Transom 73mm		DF703	135mm Subcill		DF048	24mm TBT Vent Glazing Bead
	DF1428	63mm Reverse Mullion/Transom		DF704	155mm Subcill		DF049	24mm Outerframe Glazing Bead
	DF1429	73mm Reverse Mullion/Transom		DF705	190mm Subcill		DF055	28mm TBT Vent Glazing Bead
				DF715	Pressed Nosing Subcill		DF056	28mm Outerframe Glazing Bead

Profiles Dualframe 75mm Si Casement Windows

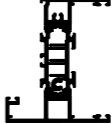

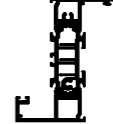







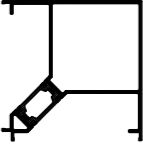
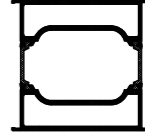

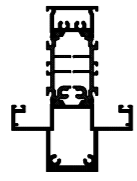

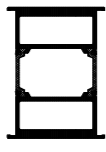
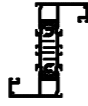

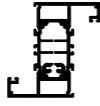

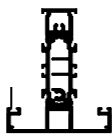

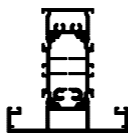





Illustration	Part No.	Description	Illustration	Part No.	Description	Illustration	Part No.	Description
Outerframe Profiles								
	DF1400	Square Outerframe		DF1407	Square Outerframe Extended Leg		DF047	Reverse Rebate Adaptor
	DF1401	Square Outerframe Extended		DF1408	Unequal Leg Square Outerframe Open Out		DF072	25mm Coupler
	DF1402	HD Window Wall Outerframe		DF1409	21mm Universal Outerframe		DF073	Coupler
	DF1403	Window Wall Outerframe		DF1410	31mm Universal Outerframe		16323	Face Applied Dummy Mullion/Transom
	DF1404	Unequal Leg Square Outerframe Open In					UF500	90° Corner Post
							UF503	75mm Heavy Duty Coupler

Illustration	Part No.	Description	Illustration	Part No.	Description	Illustration	Part No.	Description
	UF504	25mm Heavy Duty Coupler		DF1422	Heavy Duty Mullion/Transom 73mm		DF1413	Heavy Duty Square Vent Open Out Glaze In
	UF505	50mm Heavy Duty Coupler		DF1428	63mm Reverse Mullion/Transom		DF703	135mm Subcill
	UF508	Trickle Vent Body		DF1429	73mm Reverse Mullion/Transom		DF704	155mm Subcill
Mullion & Transom Profiles								
	DF1420	Mullion/Transom Flat 63mm					DF705	190mm Subcill
	DF1421	Wide Mullion/Transom Flat 73mm		DF1412	Square Vent Open Out Glaze In		DF713	100mm Subcill
Ventframe Profiles								

Cill Profiles

Ventframe Profiles

Illustration	Part No.	Description
	DF715	Pressed Nosing Subcill
Glazing Beads		
	DF046	32mm Outerframe Glazing Bead
	DF049	24mm Outerframe Glazing Bead
	DF056	28mm Outerframe Glazing Bead

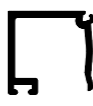



















Profile Inertia Values Dualframe 75mm Si Tilt Before Turn Windows

This page gives information on the inertia values of the framing profiles calculated in accordance with :- BS EN 14024 : 2004.

BS6399 Part 2 must be used to calculate the inertia value required.

The table gives inertia values for varying spans of profile. Select the nearest span BELOW the actual span and use the value shown to compare against the inertia required.

Values shown are mm⁴

Profile	Span 750mm	Span 900mm	Span 1050mm	Span 1200mm	Span 1350mm	Span 1500mm	Span 1650mm	Span 1800mm	Span 1950mm	Span 2100mm	Span 2250mm	Span 2400mm	Inertia I _{yy}
 DF1400	99,876	122,644	143,205	161,067	176,619	189,857	201,167	210,827	218,885	225,635	231,585	237,004	39,639
 DF1401	109,752	136,620	161,614	184,543	204,662	222,288	237,636	250,996	262,565	272,528	281,347	288,722	76,085
 DF1402	372,582	425,738	477,044	525,018	568,712	607,925	642,630	673,347	700,469	724,208	744,961	763,225	46,900
 DF1403	352,133	401,598	447,760	489,421	526,228	558,370	586,237	610,385	631,115	649,187	664,797	678,323	24,142
 DF1404	107,462	132,701	155,676	176,129	193,968	209,095	222,336	233,607	243,240	251,638	258,596	264,628	77,372
 DF1407	121,175	151,313	179,661	205,304	228,215	248,605	266,147	281,135	294,296	305,967	315,639	324,696	95,651
 DF1408	112,772	140,038	165,100	187,619	207,591	224,861	239,545	252,501	263,289	273,090	281,061	288,428	57,828
 DF1409	88,496	107,522	124,340	138,754	150,944	161,224	169,700	176,739	182,805	187,966	192,379	196,278	8,881
 DF1410	100,379	124,329	146,517	166,173	183,681	198,670	211,462	222,807	232,338	240,653	247,833	253,620	30,276
 DF1420	112,295	138,943	163,484	185,230	204,328	220,978	235,093	247,120	257,838	266,736	274,310	280,788	103,317
 DF1421	116,587	145,890	173,799	199,416	222,541	242,954	260,811	276,535	290,639	302,319	312,881	321,988	163,046
 DF1422	253,294	298,547	342,725	384,216	422,338	456,789	487,544	514,837	538,836	560,157	578,946	595,624	193,190
 DF1428	112,420	139,741	165,116	187,932	207,918	225,614	240,904	253,805	264,985	274,761	283,219	290,586	70,397
 DF1429	119,536	149,652	178,104	204,398	228,175	248,995	267,380	283,482	297,830	310,092	320,653	330,213	121,893
 DF1430	148,741	180,606	210,834	238,445	263,053	284,839	304,024	320,436	335,054	347,689	358,624	368,067	82,455
 DF072													36,058
 UF500	430,572	443,678	455,592	466,120	475,214	483,036	489,716	495,414	500,283	504,447	508,007	511,095	Previous
 UF503	193,491	231,827	272,115	312,949	353,151	392,070	428,912	463,643	496,215	525,878	553,554	578,714	668,973
 UF504	151,916	182,776	213,008	241,655	268,142	292,195	313,876	333,100	350,141	365,258	378,654	390,550	43,773
 UF505	202,505	242,898	284,823	326,878	368,031	407,286	444,199	478,736	510,469	539,567	566,238	590,683	261,434









Profile Inertia Values Dualframe 75mm Si Casement Windows

This page gives information on the inertia values of the framing profiles calculated in accordance with :- BS EN 14024 : 2004.

BS6399 Part 2 must be used to calculate the inertia value required.

The table gives inertia values for varying spans of profile. Select the nearest span BELOW the actual span and use the value shown to compare against the inertia required.

Values shown are mm⁴

Profile	Span 750mm	Span 900mm	Span 1050mm	Span 1200mm	Span 1350mm	Span 1500mm	Span 1650mm	Span 1800mm	Span 1950mm	Span 2100mm	Span 2250mm	Span 2400mm	Inertia I _{yy}
 DF1400	99,876	122,665	143,205	161,067	176,619	189,857	201,167	210,827	218,885	225,635	231,586	237,004	39,639
 DF1401	109,752	136,620	161,614	184,543	204,662	222,288	237,636	250,996	262,565	272,528	281,347	288,722	76,085
 DF1402	372,582	425,738	477,044	525,018	568,712	607,925	642,630	673,347	700,469	724,208	744,961	763,225	49,900
 DF1403	352,133	401,598	447,760	489,421	526,228	558,370	586,237	610,385	631,115	649,187	664,797	678,323	24,142
 DF1404	107,462	132,701	155,676	176,129	193,968	209,095	222,336	233,607	243,240	251,538	258,596	264,628	77,372
 DF1407	121,175	151,313	179,661	205,304	228,215	248,605	266,147	281,135	294,296	305,967	315,639	324,696	95,561
 DF1408	112,772	140,038	165,100	187,619	207,591	224,861	239,545	252,501	263,289	273,090	281,061	288,428	57,828
 DF1409	88,496	107,522	124,340	138,754	150,944	161,224	169,700	176,739	182,805	187,966	192,379	196,278	8,881
 DF1410	100,379	124,329	146,517	166,173	183,681	198,670	211,462	222,807	232,338	240,653	247,833	253,620	30,276
 DF1412	83,425	102,880	120,796	136,663	150,682	162,657	173,026	181,846					85,981
 DF1413	85,545	105,038	123,087	139,138	153,253	165,379	175,863	184,810					99,983
 DF1420	112,295	138,943	163,484	185,230	204,328	220,978	235,093	247,120	257,838	266,736	274,310	280,788	103,317
 DF1421	116,587	145,890	173,799	199,416	222,541	242,954	260,811	276,535	290,639	302,319	312,881	321,988	163,046
 DF1422	253,294	298,547	342,725	384,216	422,338	456,789	487,544	514,837	538,836	560,157	578,946	595,624	193,190
 DF1428	112,420	139,741	165,116	187,932	207,918	225,614	240,904	253,805	264,985	274,761	283,219	290,586	70,397
 DF1429	119,536	149,652	178,104	204,398	228,175	248,995	267,380	283,482	297,830	310,092	320,653	330,213	121,893
 DF072													36,058
 UF500	430,572	443,678	455,592	466,120	475,214	483,036	489,716	495,414	500,283	504,447	508,007	511,095	Previous
 UF503	193,491	231,827	272,115	312,949	353,151	392,070	428,912	463,643	496,215	525,878	553,554	578,714	668,973
 UF504	151,916	182,776	213,008	241,655	268,142	292,195	313,876	333,100	350,141	365,258	378,654	390,550	43,773
 UF505	202,505	242,898	284,823	326,878	368,031	407,286	444,199	478,736	510,469	539,567	566,238	590,683	261,434

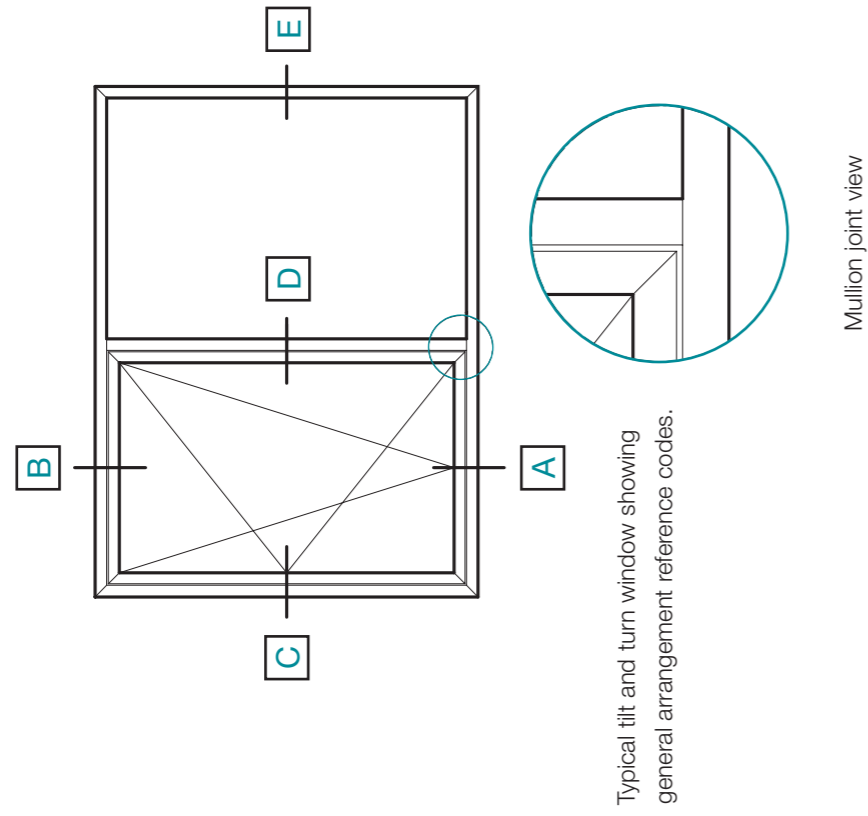

A Cill

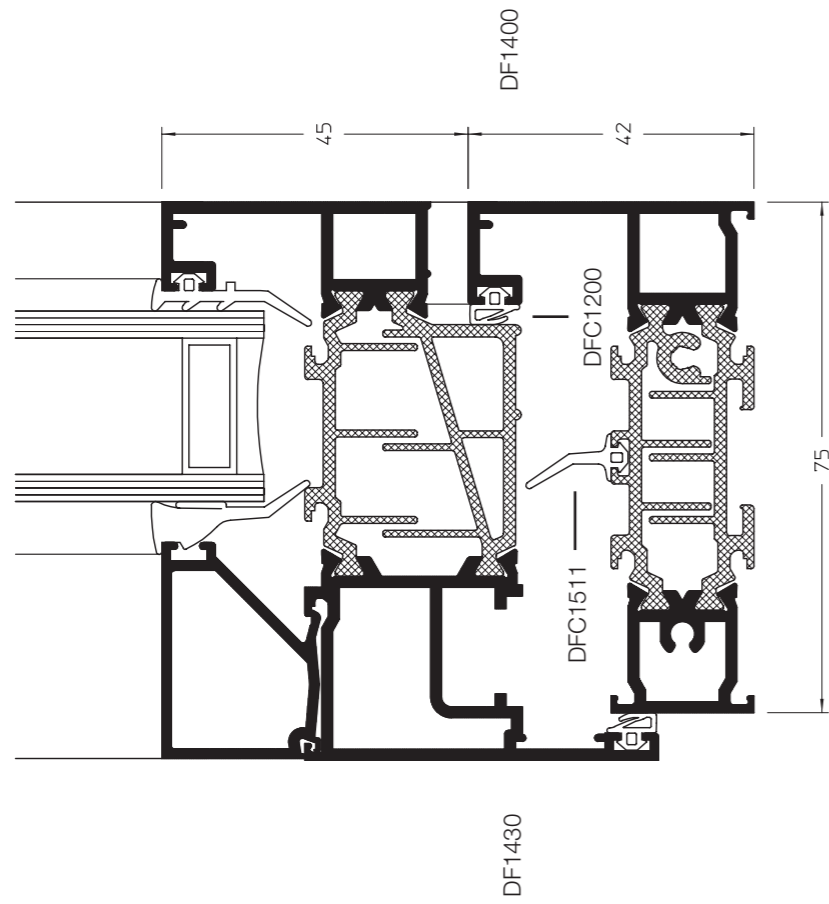

A Cill

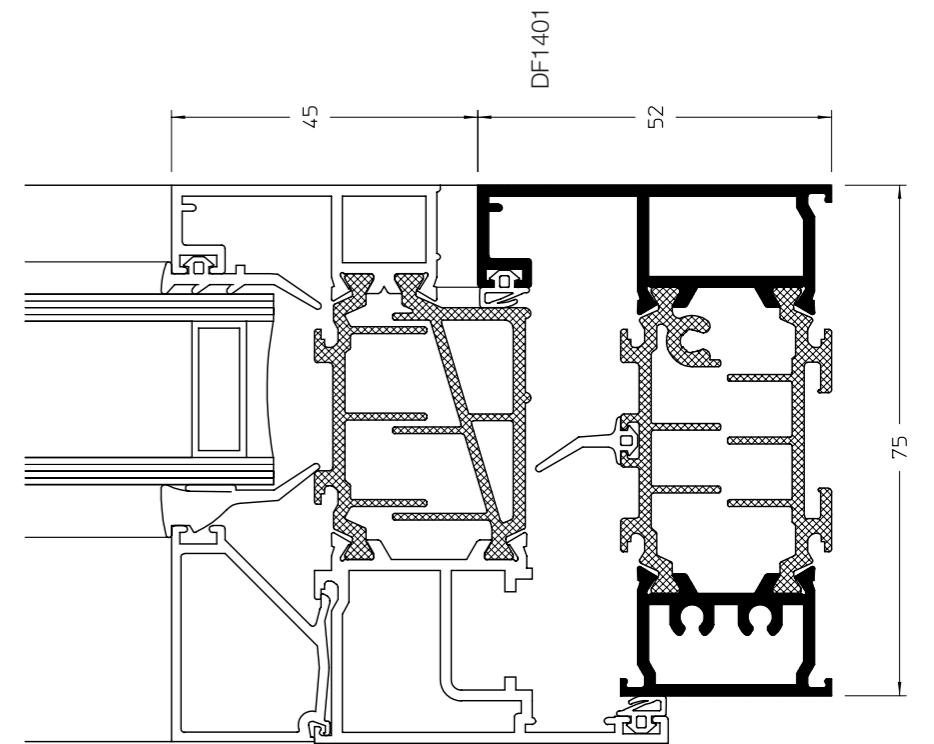

A Cill

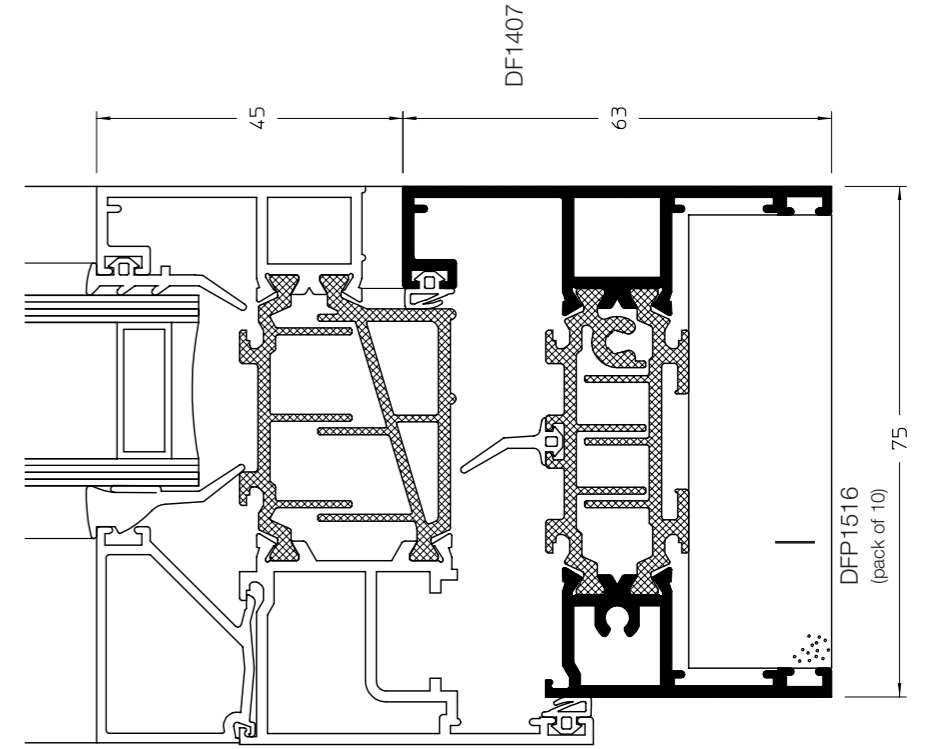

A Cill

Showing alternative unequal leg outerframe.

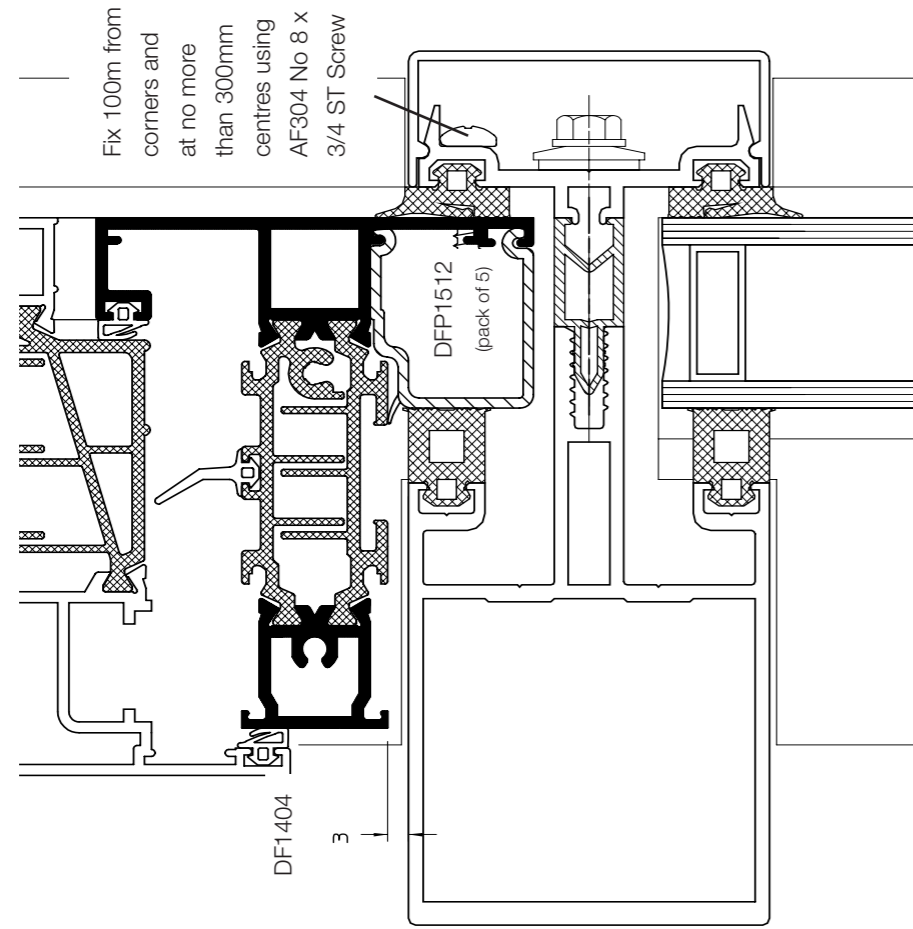

A Cill

Showing alternative unequal leg outerframe.

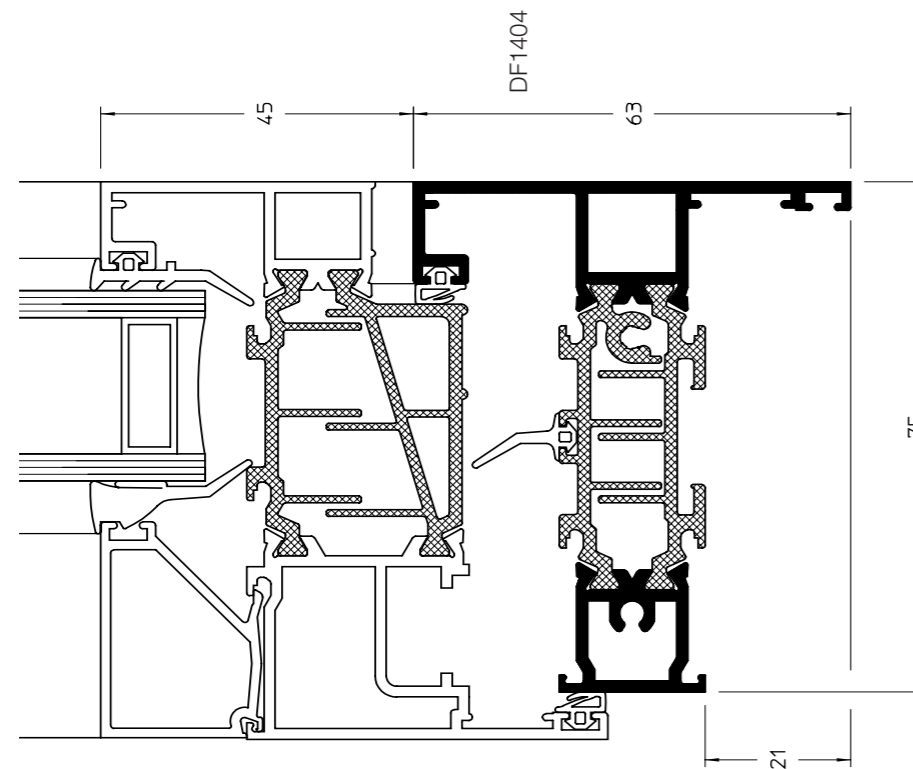

C Opening Light Jamb

Opening Light Jamb

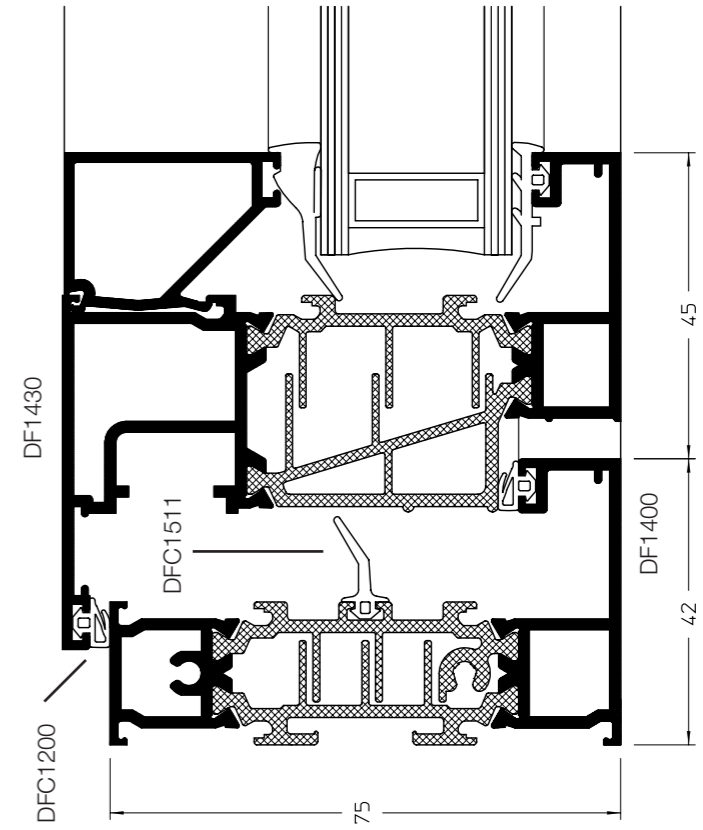

B Head

Head

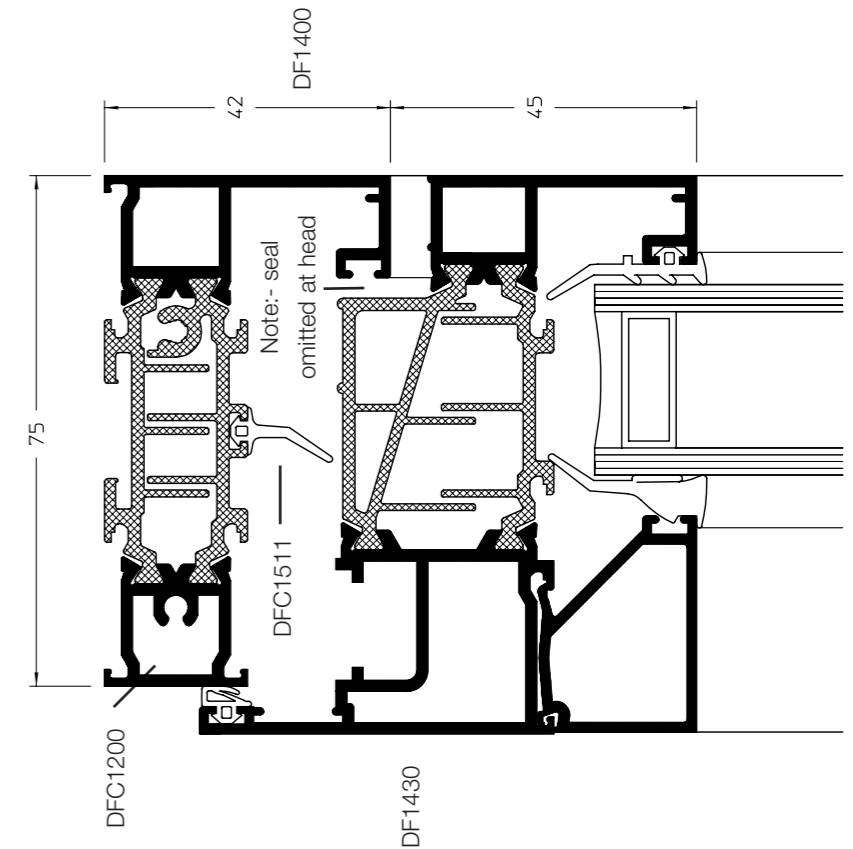

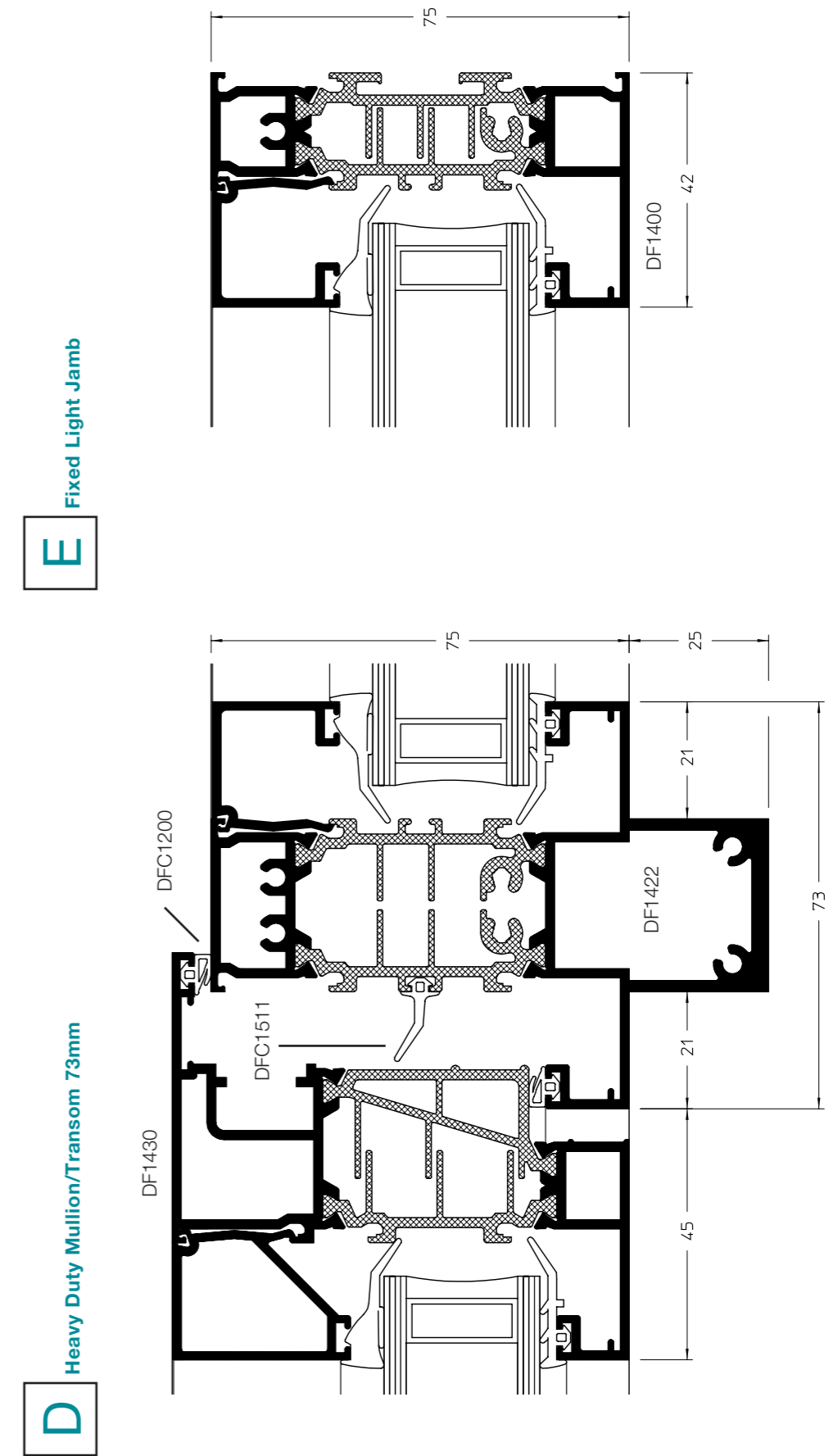
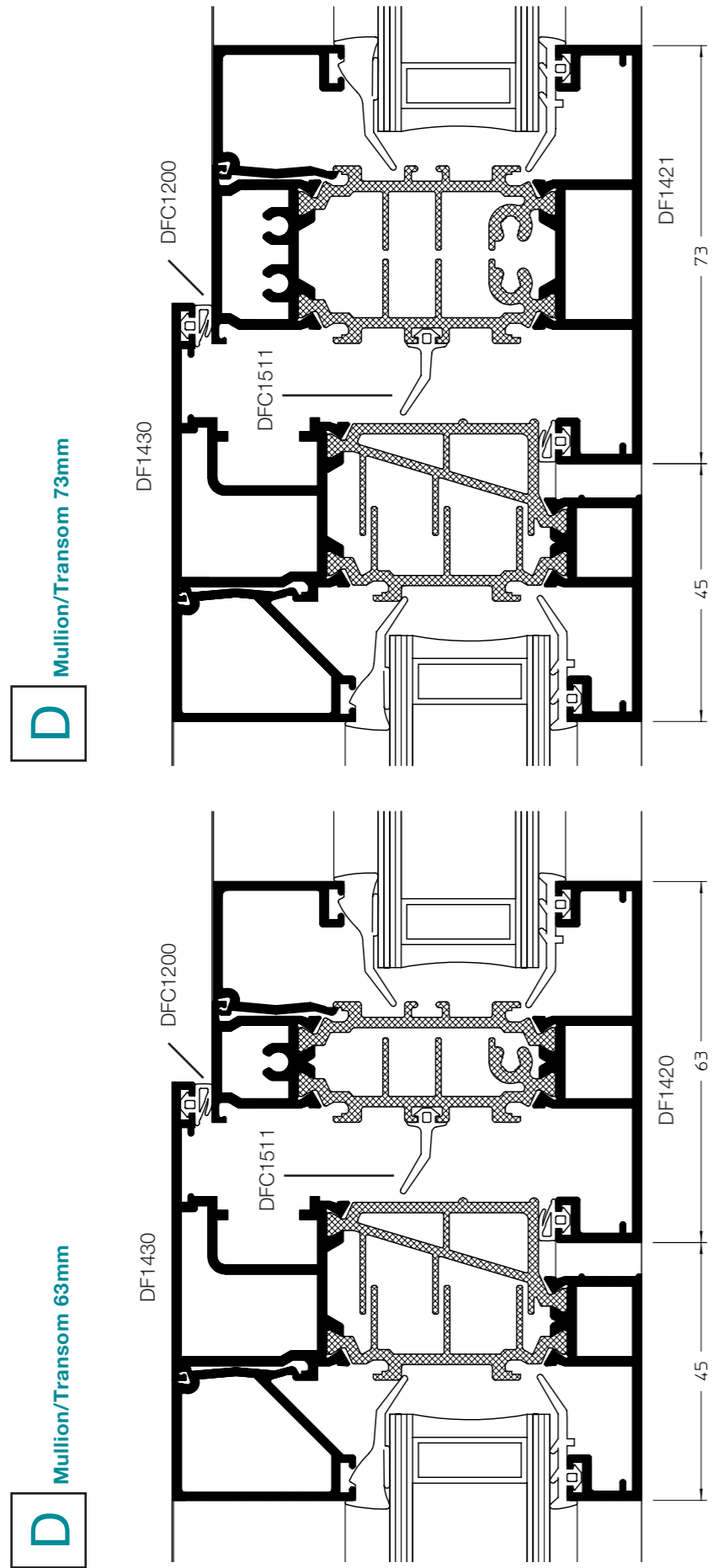

Subcills

Showing alternative subcills. Note:- DF1407 cannot be used with DF715

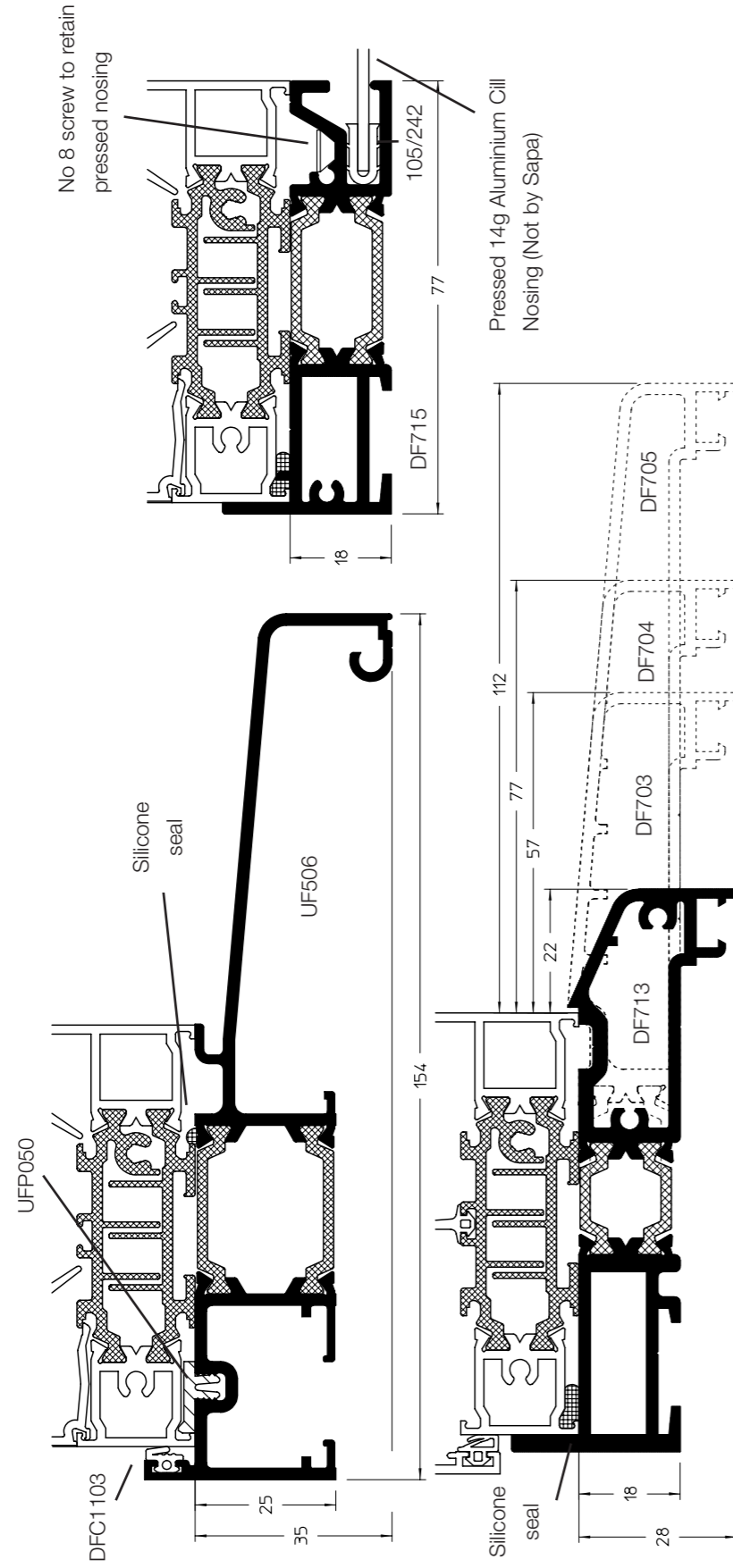

Light Weight Coupler

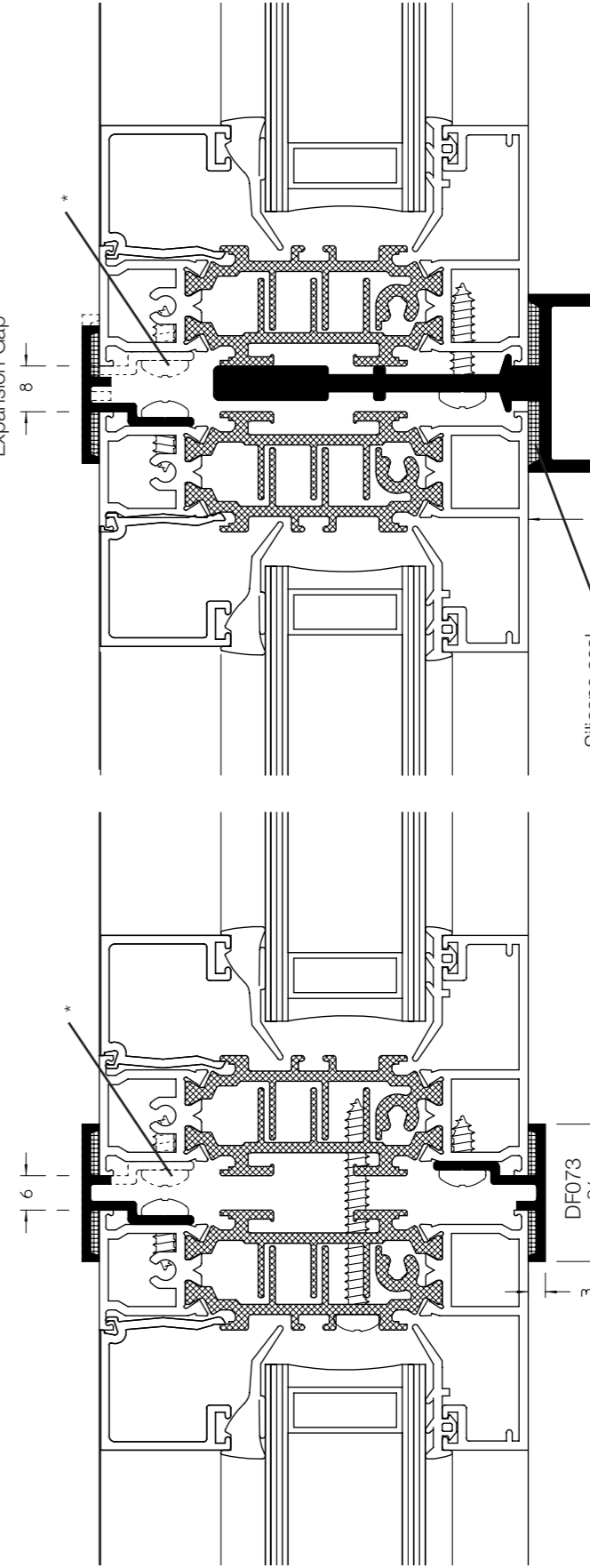

25mm Coupler

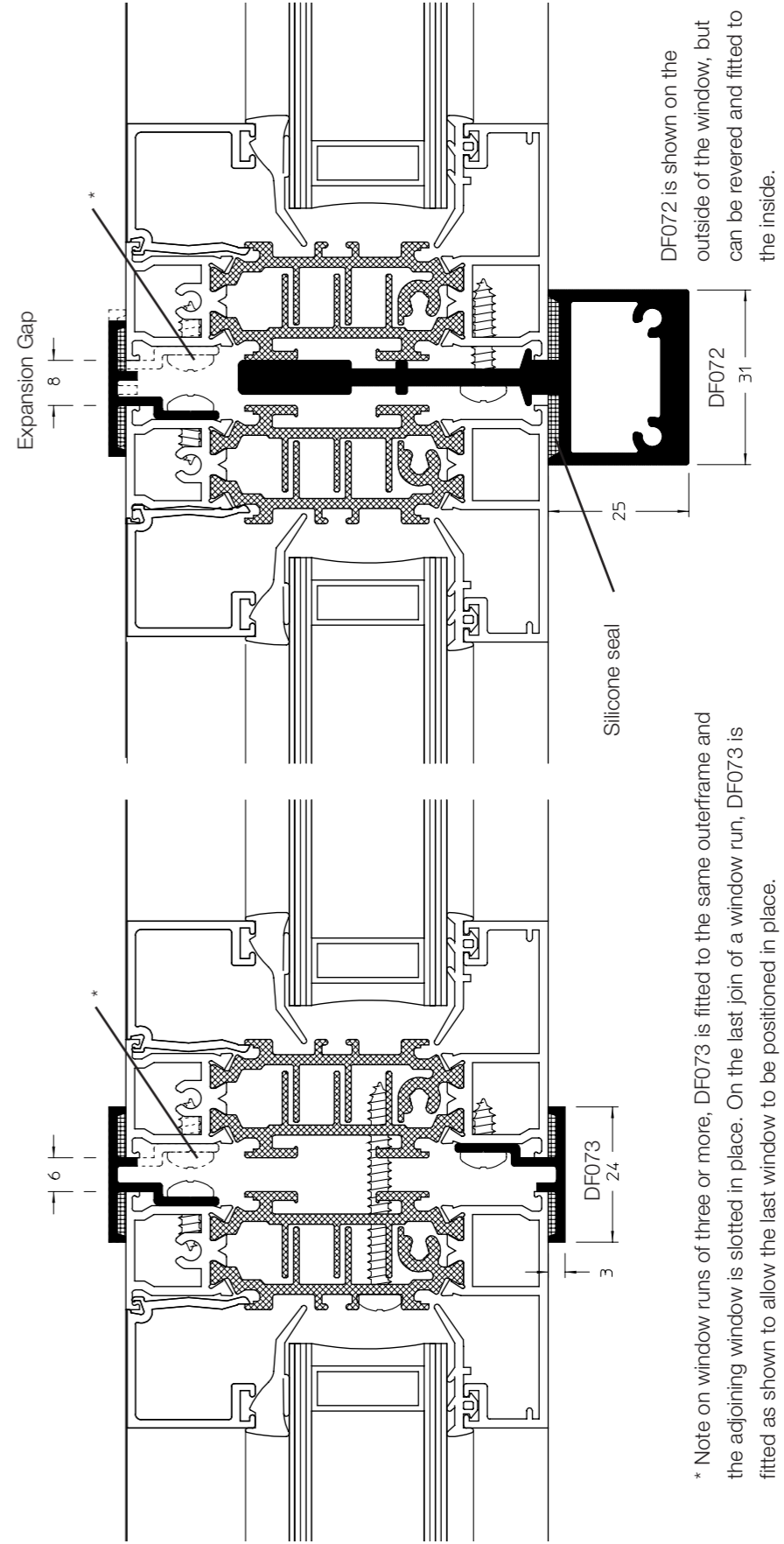

* Note on window runs of three or more, DF073 is fitted to the same outerframe and the adjoining window is slotted in place. On the last join of a window run, DF073 is fitted as shown to allow the last window to be positioned in place.

90° Corner Post

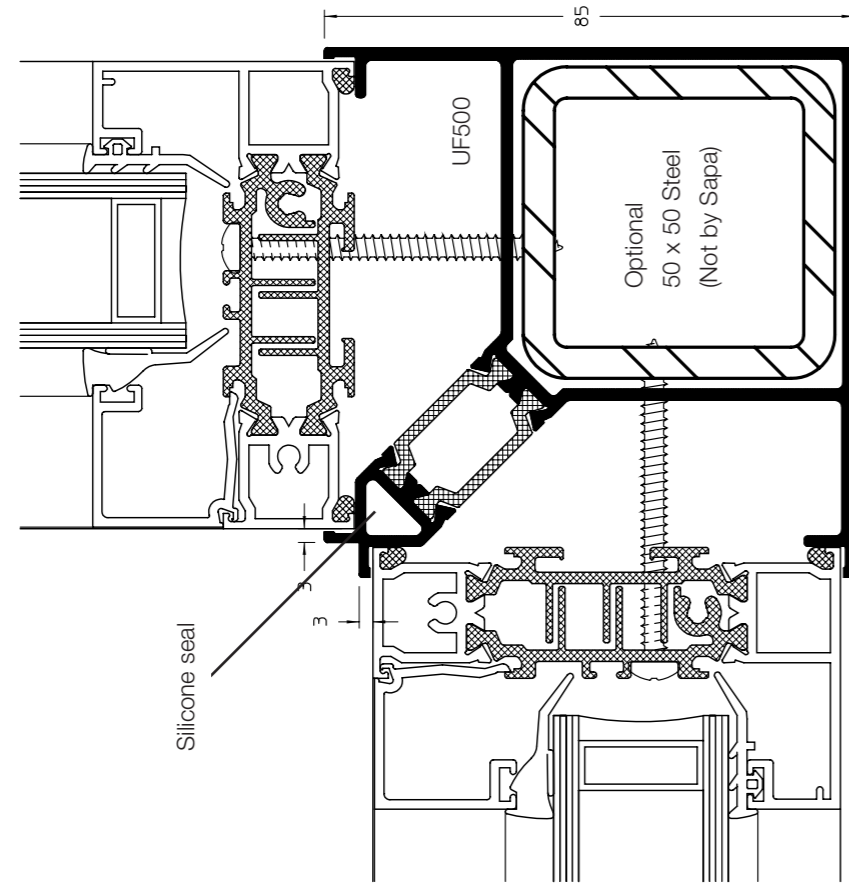

Flush Coupler

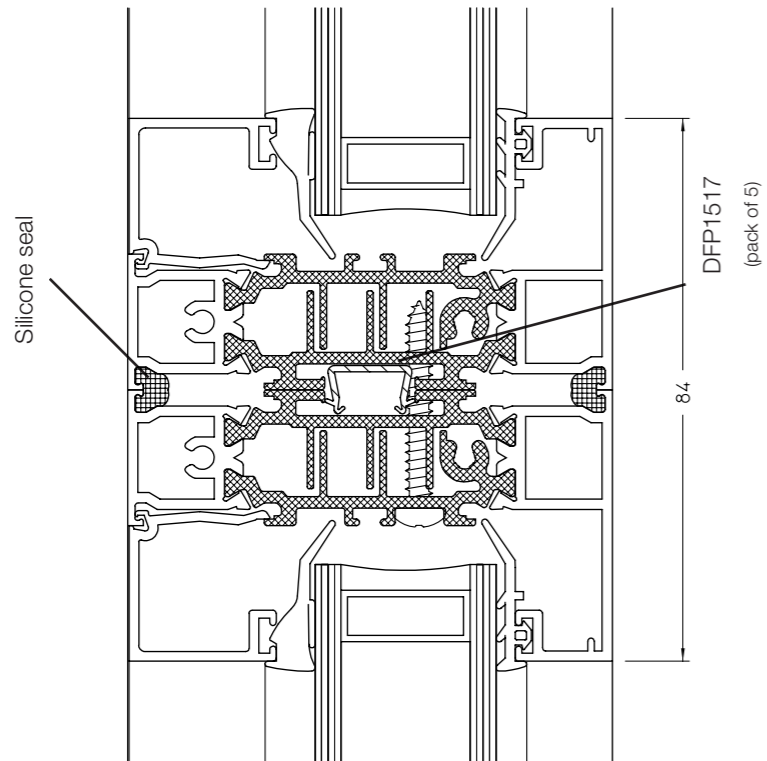

Showing outerframe DF1400.
This option is also available for DF1401 outerframe

25mm Heavy Duty Coupler

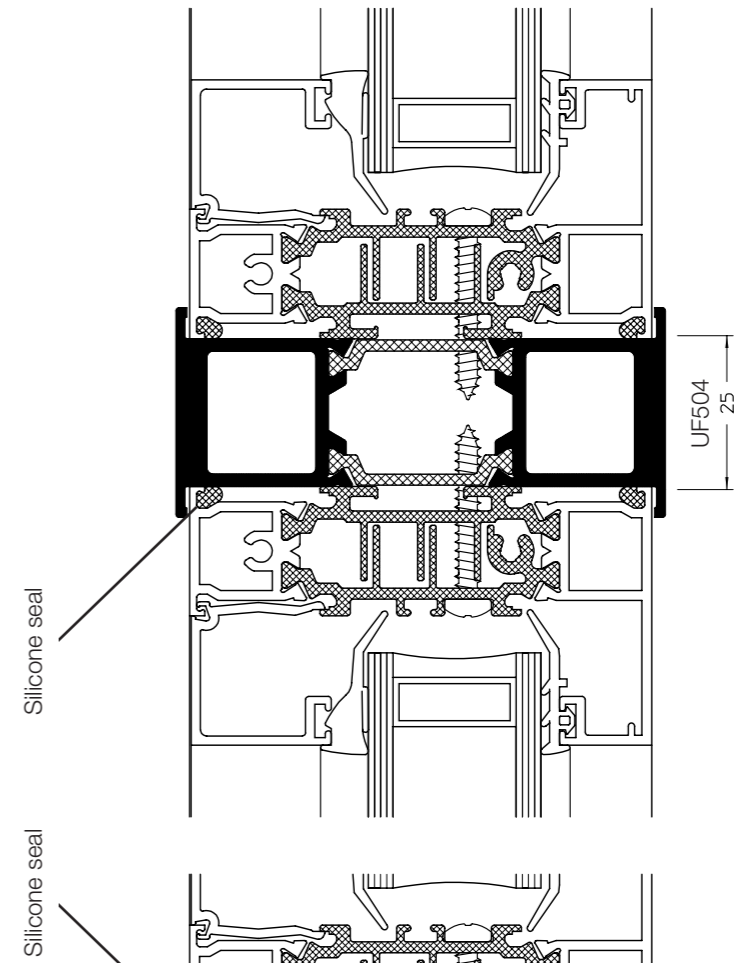

75mm Heavy Duty Coupler

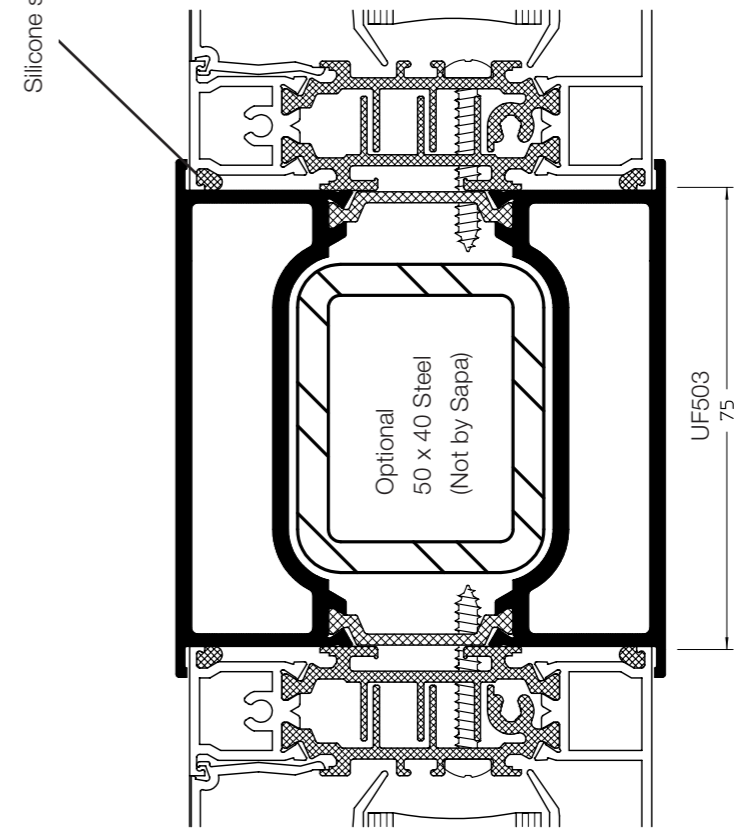

Face Applied Dummy Mullion/Transom

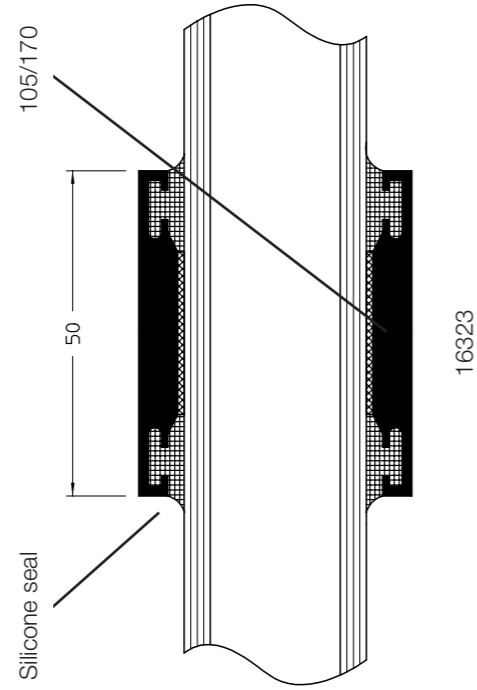

50mm Heavy Duty Coupler

Showing Dualframe 75mm Si Coupled to Dualframe 75mm

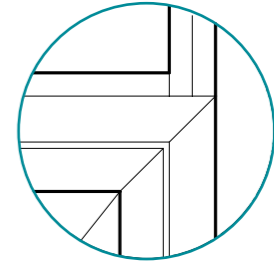
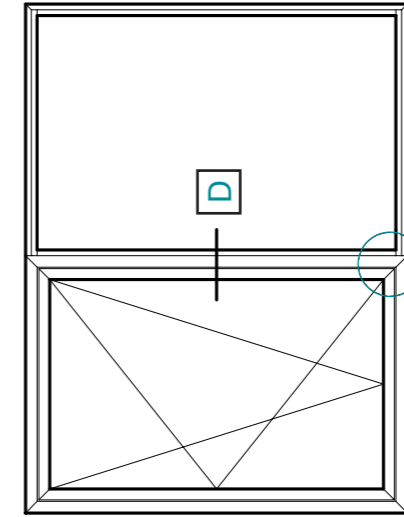
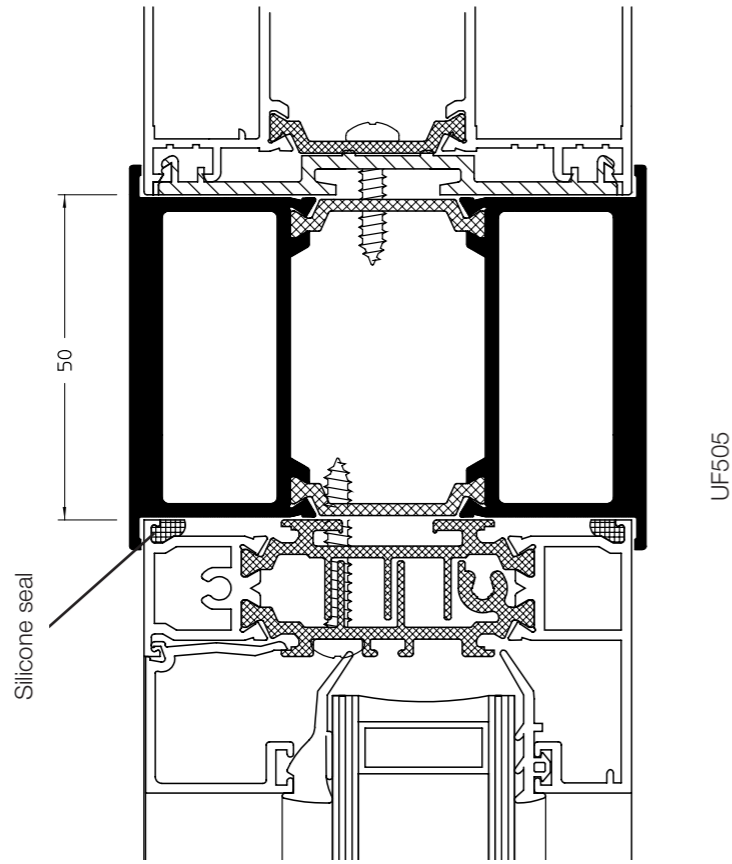

Mullion joint view

Typical tilt and turn window.

Please note that the reverse rebate adaptor can only be used in fixed lights, next to a TBT window. e.g. By the side or above/below.

The rebate adaptor can not be used in cruciform configurations.

Reverse Rebate Mullion



Showing outerframe DF1400.
This option is also available for DF1401 outerframe

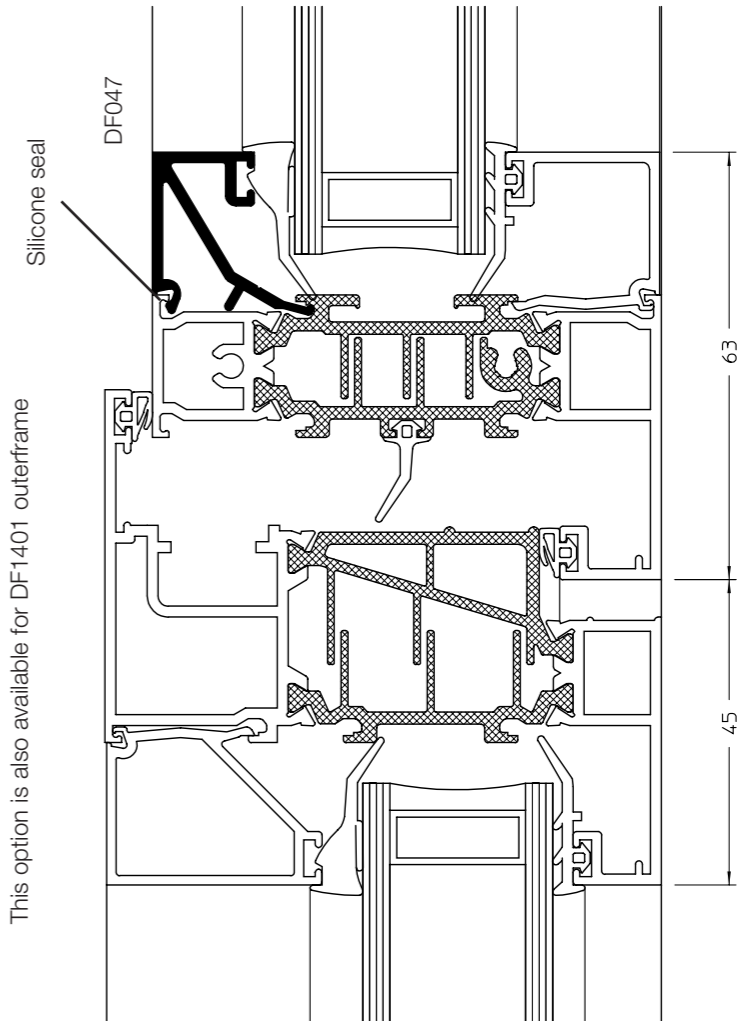

Head Vent Body

Showing optional trickle vent profile, DF1400 frame shown, other frame / vent profile combinations available.

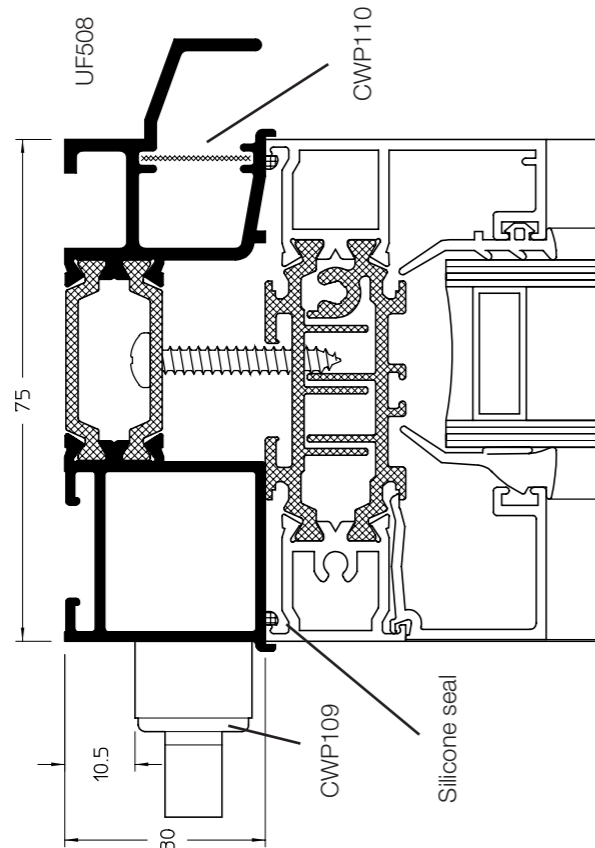

Head Vent

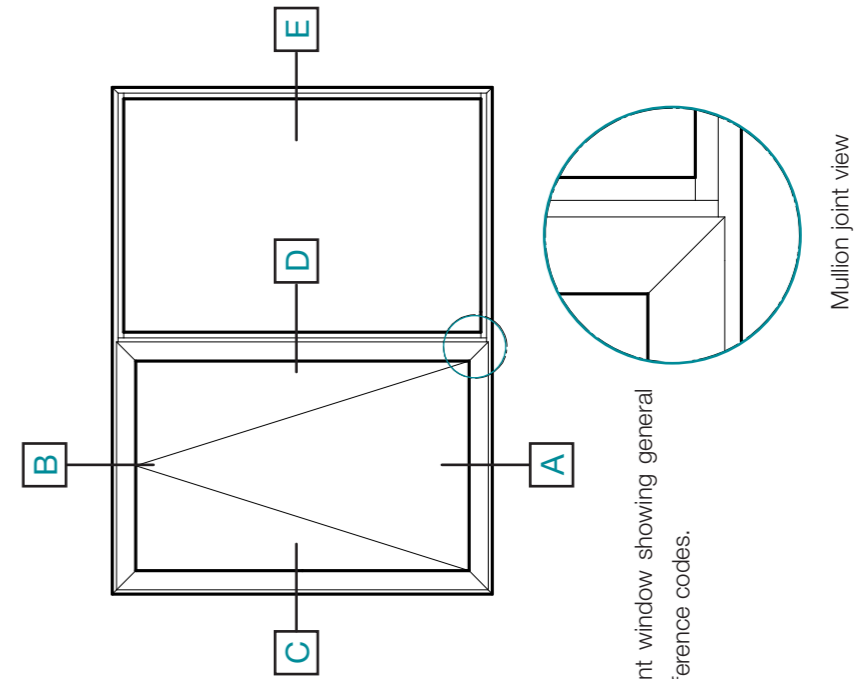
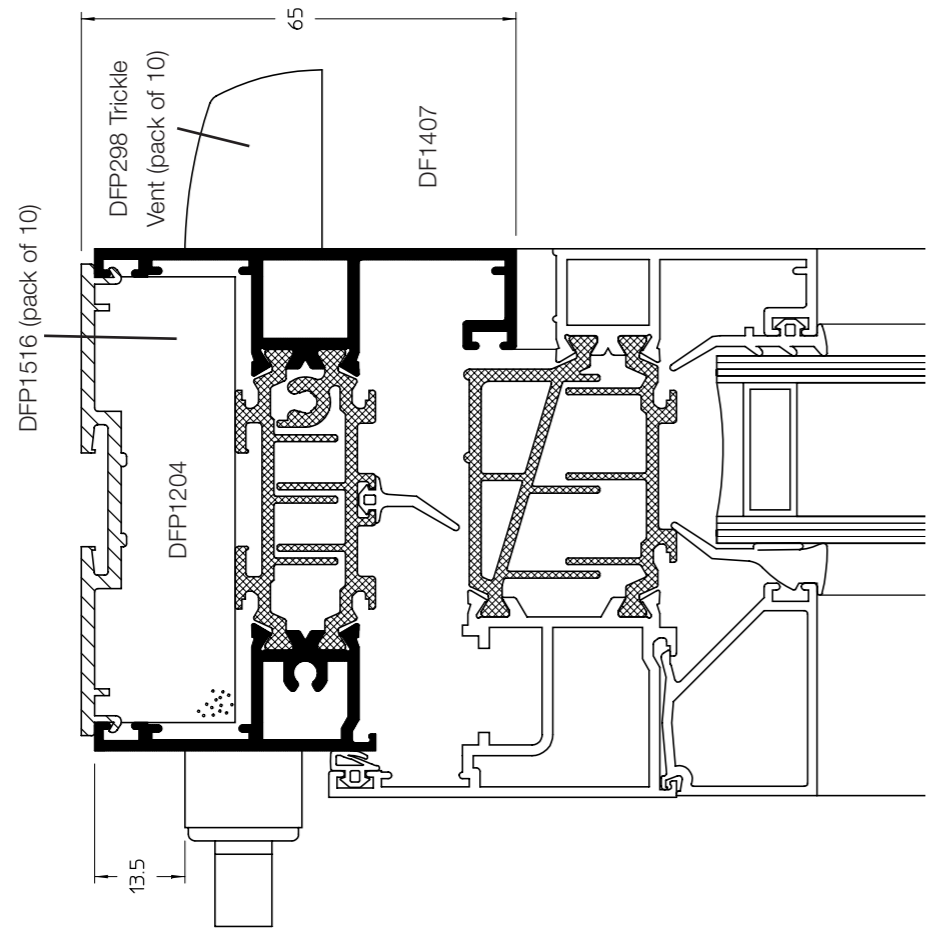

Typical casement window showing general arrangement reference codes.

Mullion joint view

A Cill

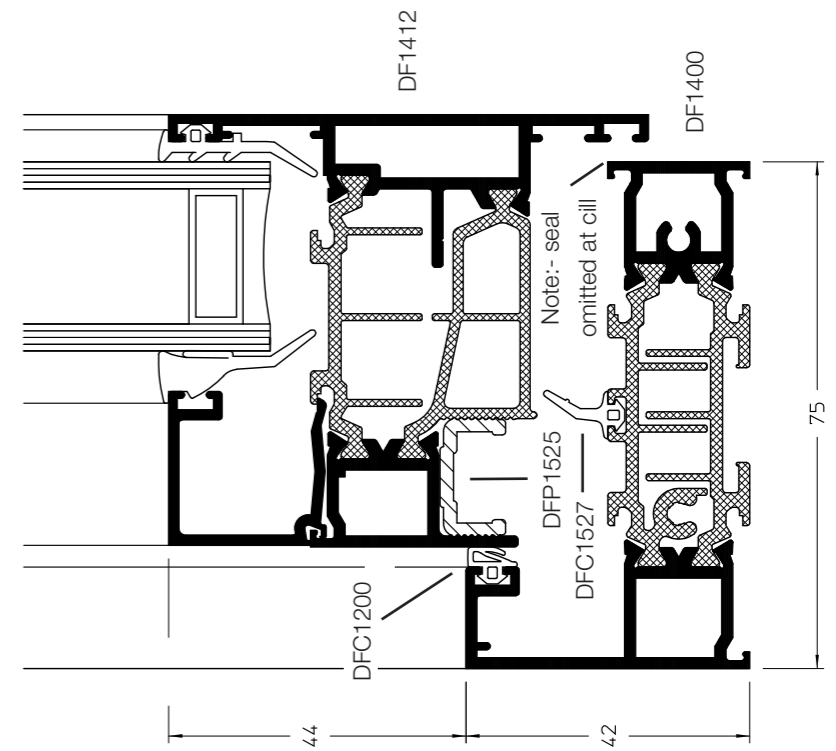

Note:- seal omitted at cill

A cill

Showing alternative heavy duty ventframe.

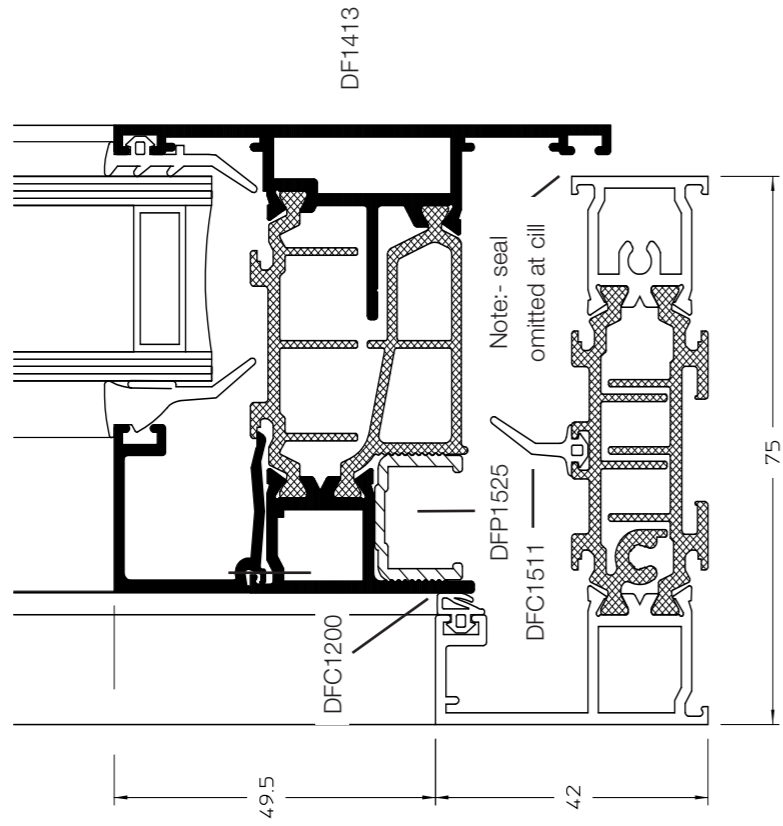

A cill

Showing alternative extended outerframe.

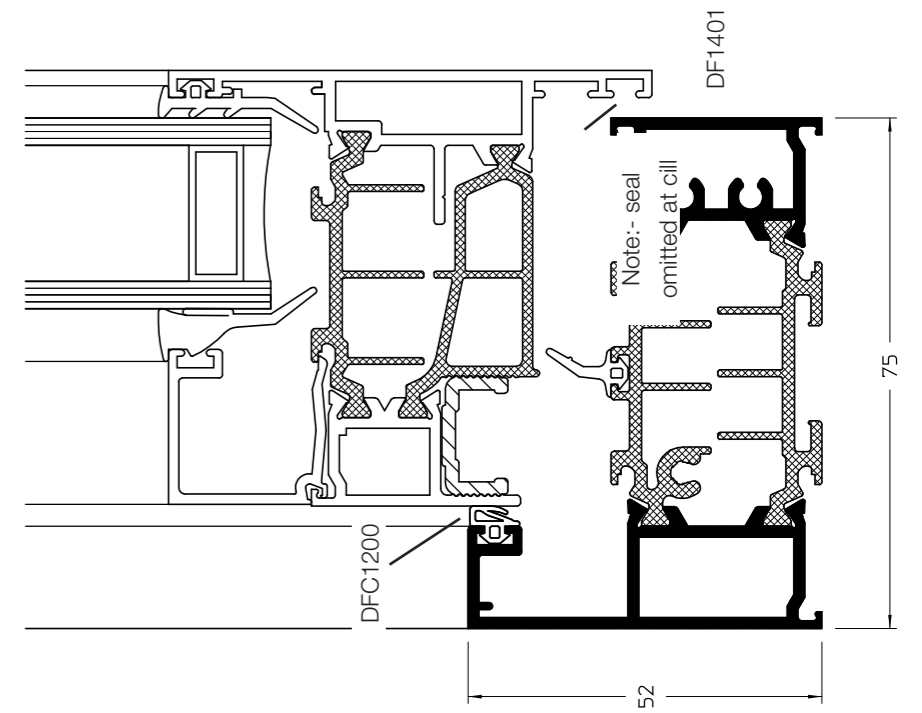

A cill

Showing alternative extended leg outerframe.

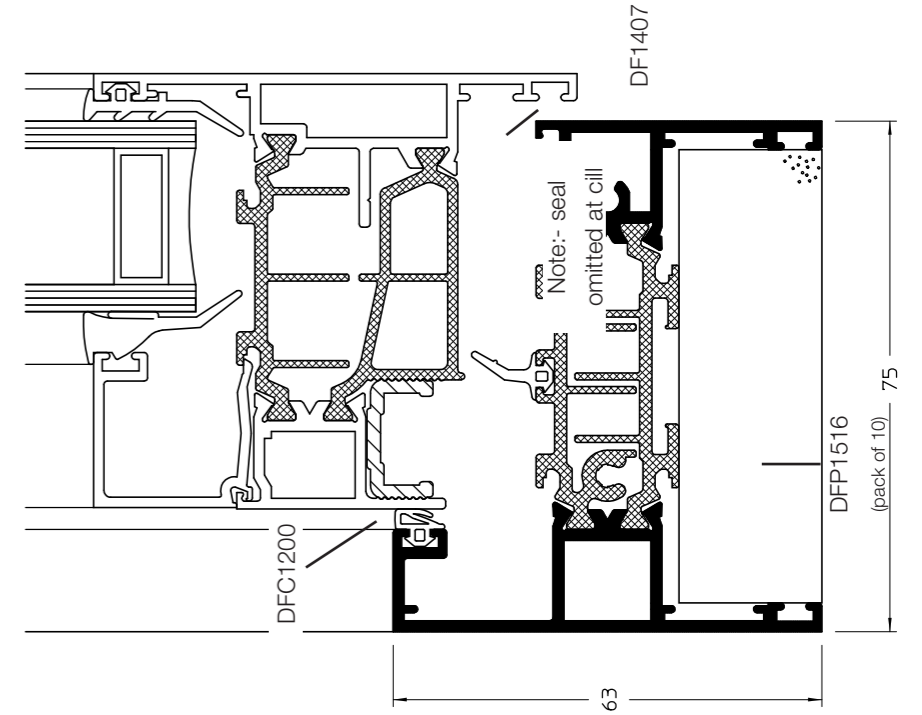

A Cill

Showing alternative unequal leg outerframe.

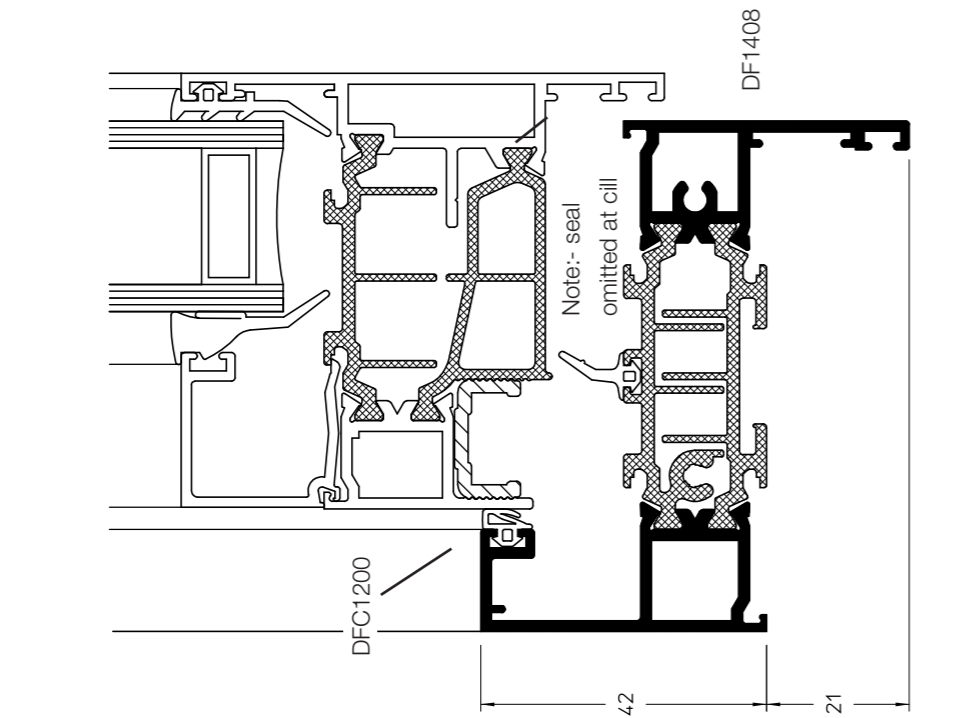

A Cill

Showing alternative curtain wall outerframe.

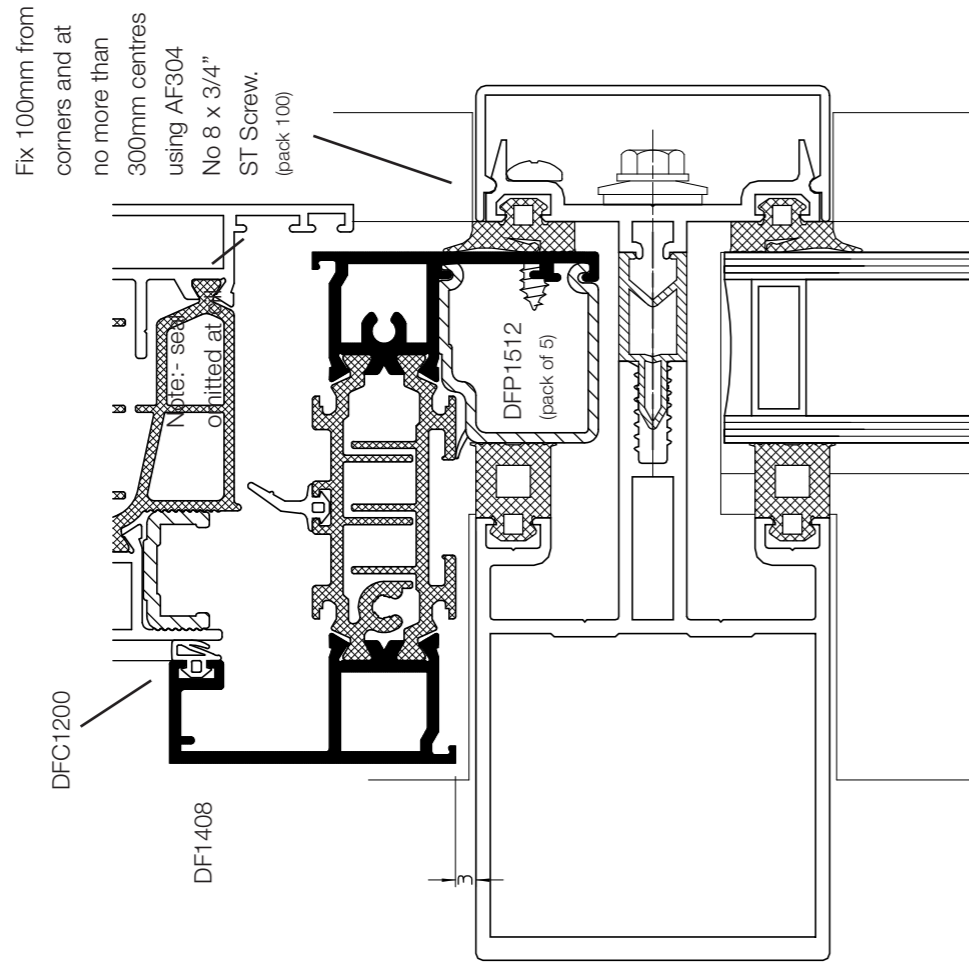

B Head

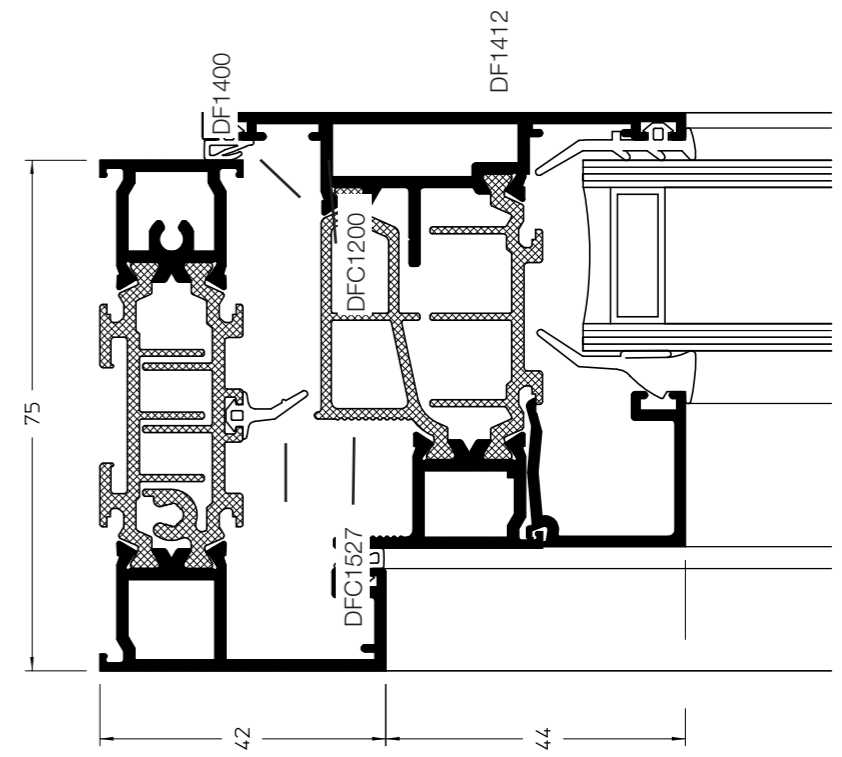

C Opening Light Jamb

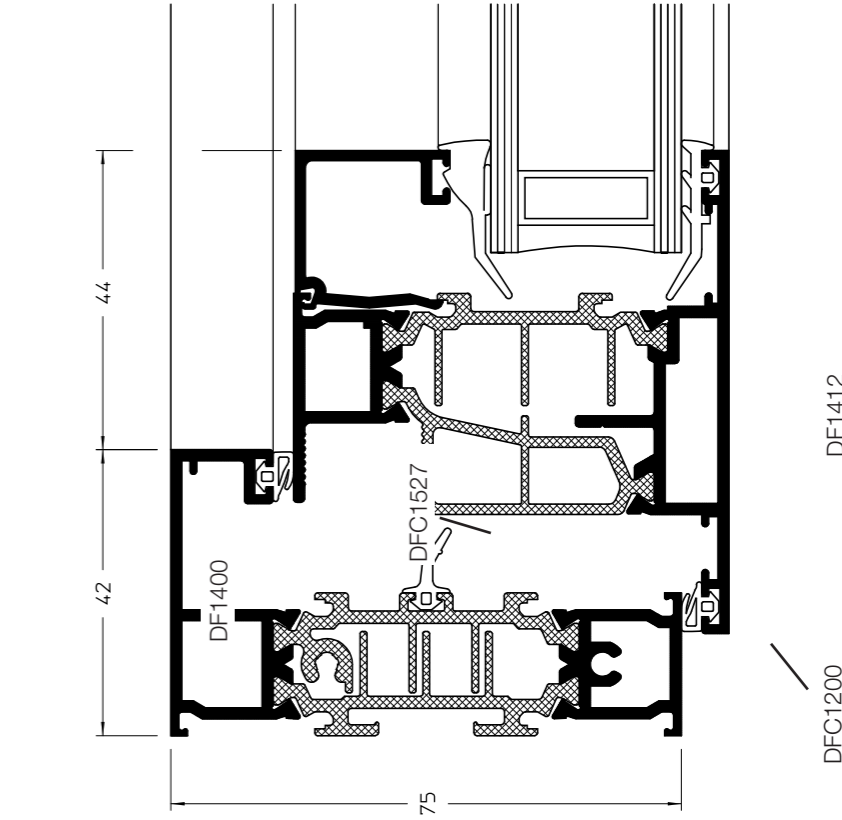

D Mullion/Transom 73mm

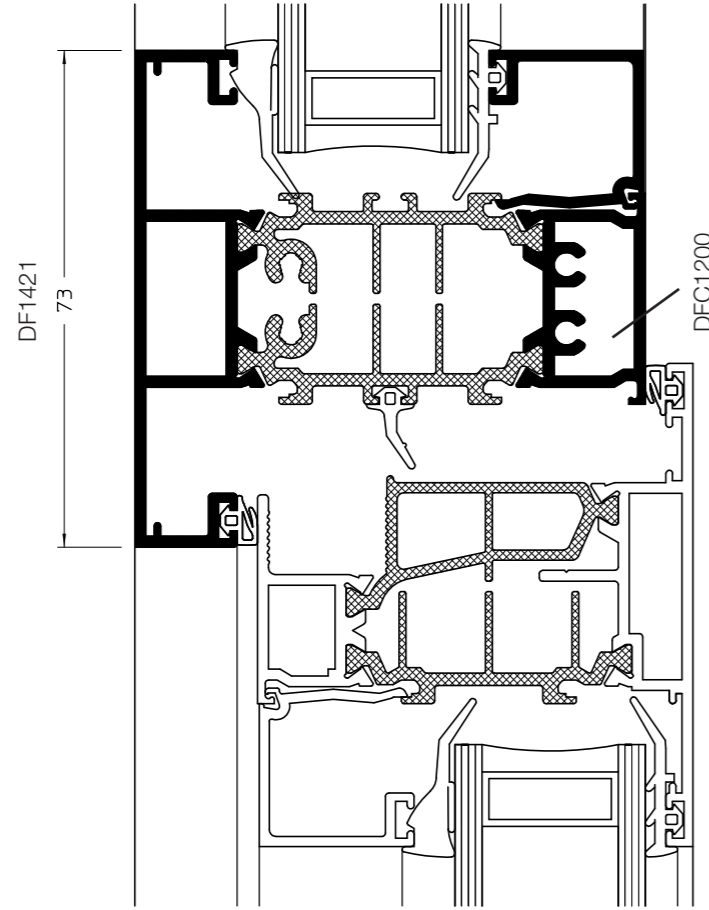

D Mullion/Transom 63mm

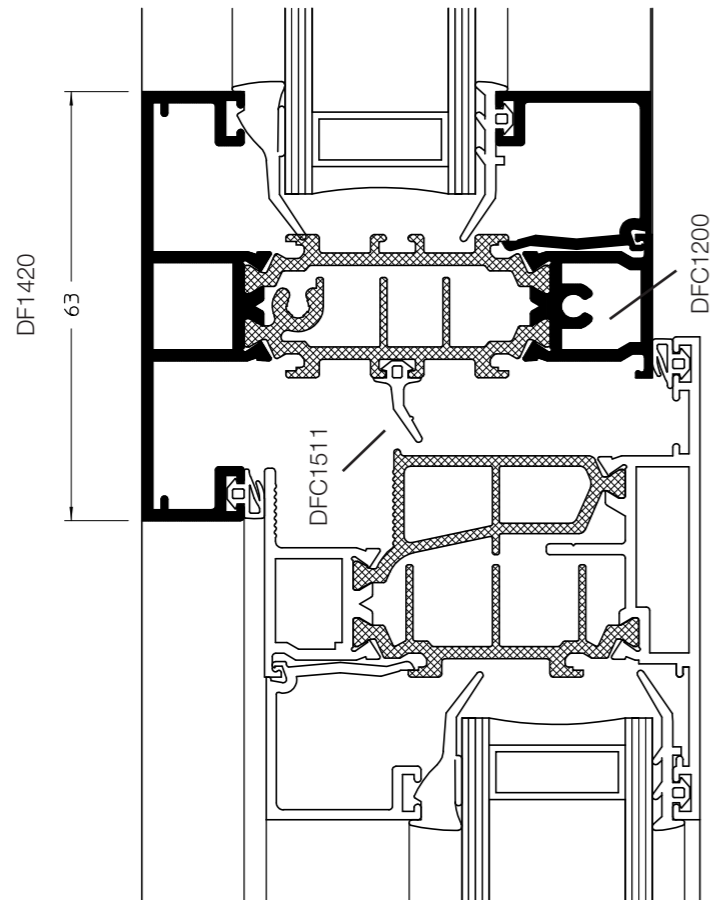

E Fixed Light Jamb

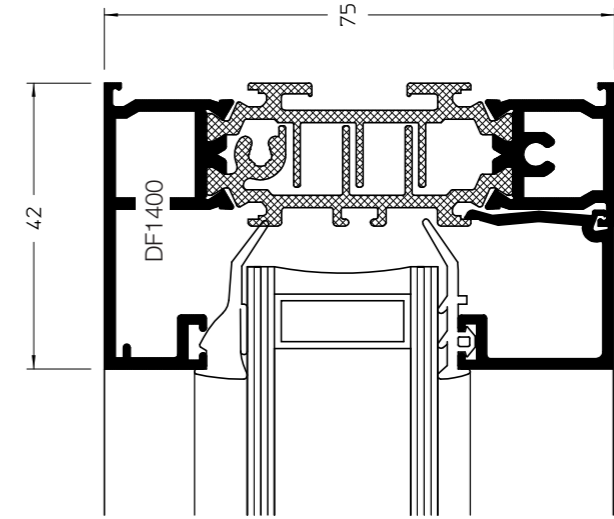

D Heavy Duty Mullion/Transom 73mm

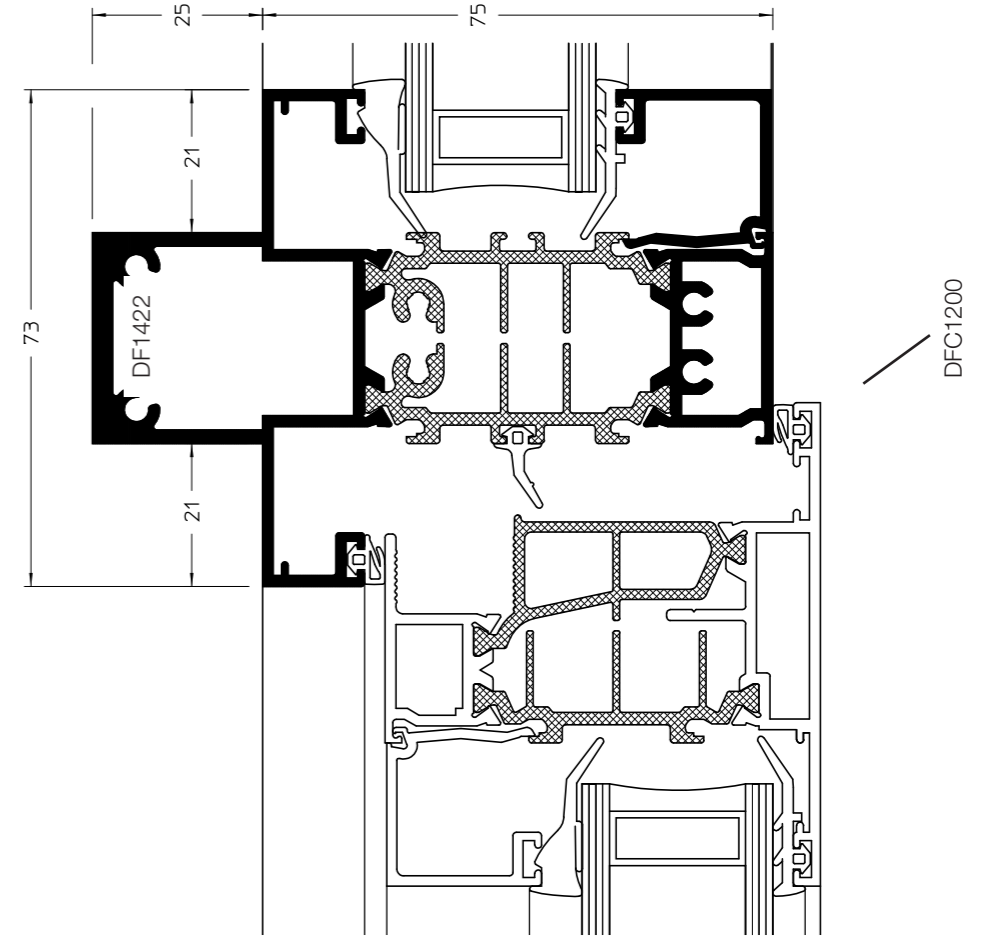

Subcills

Showing alternative subcills

Note:- DF1407 cannot be used with DF715.

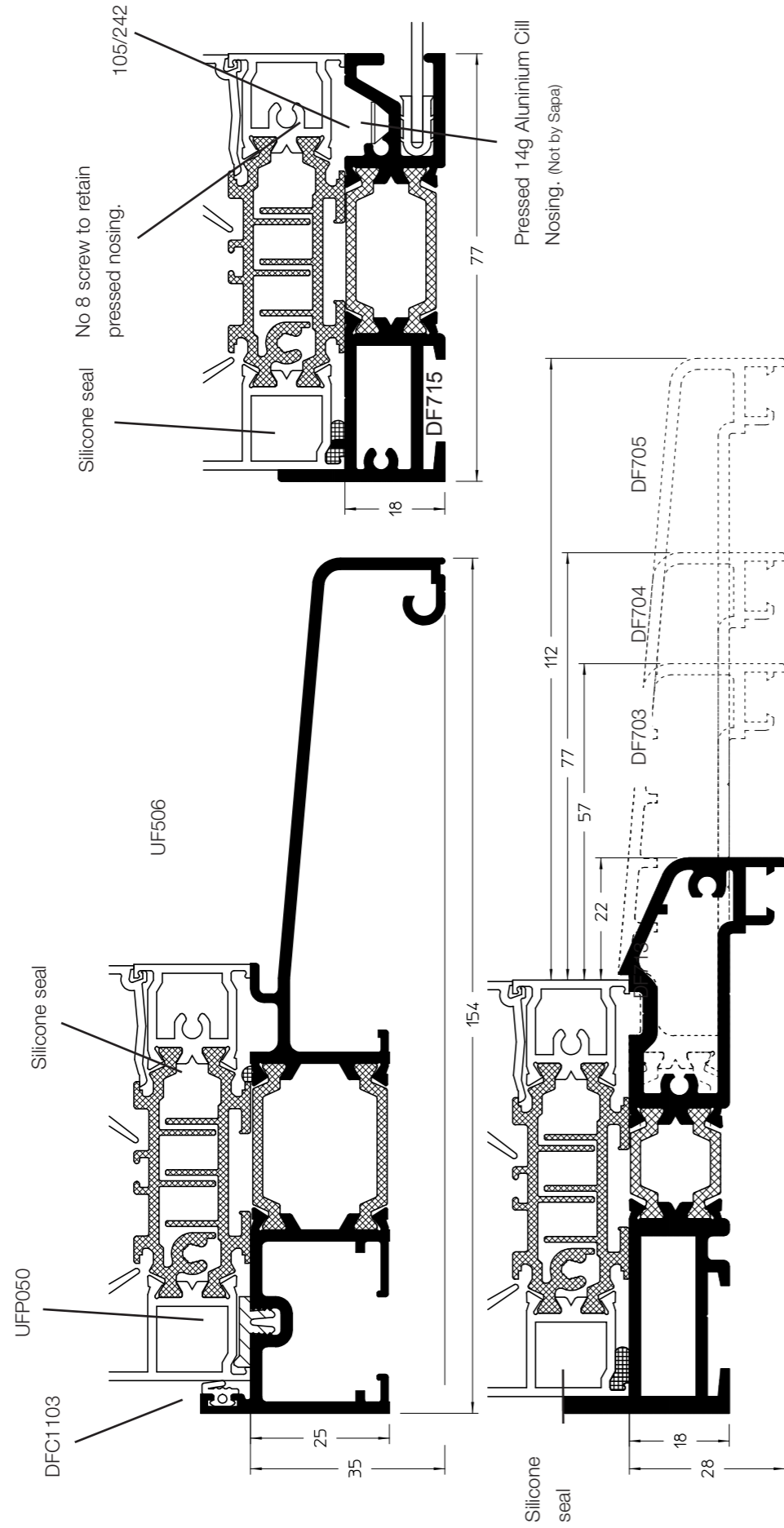

Light Weight Coupler

25mm Coupler

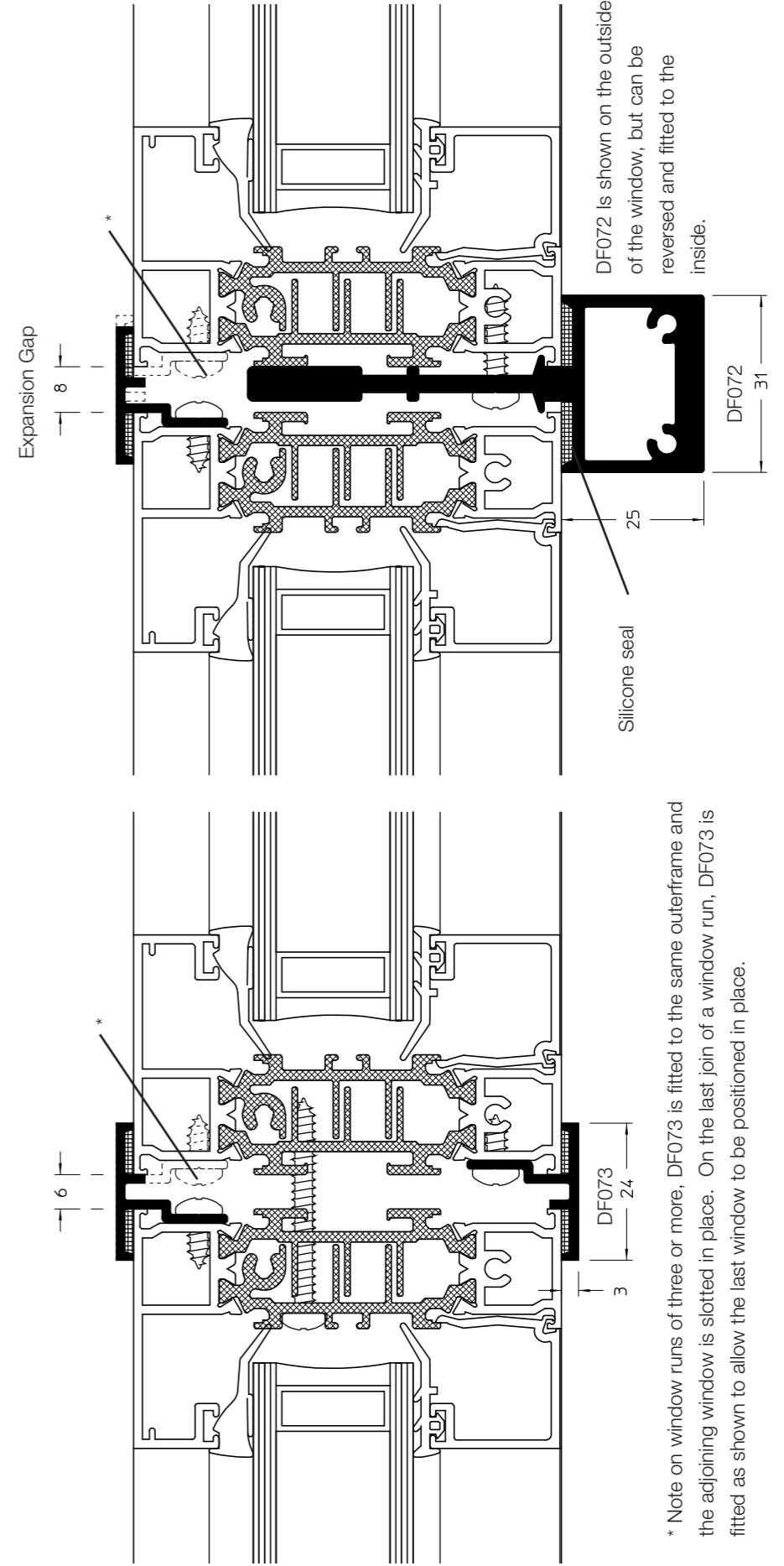

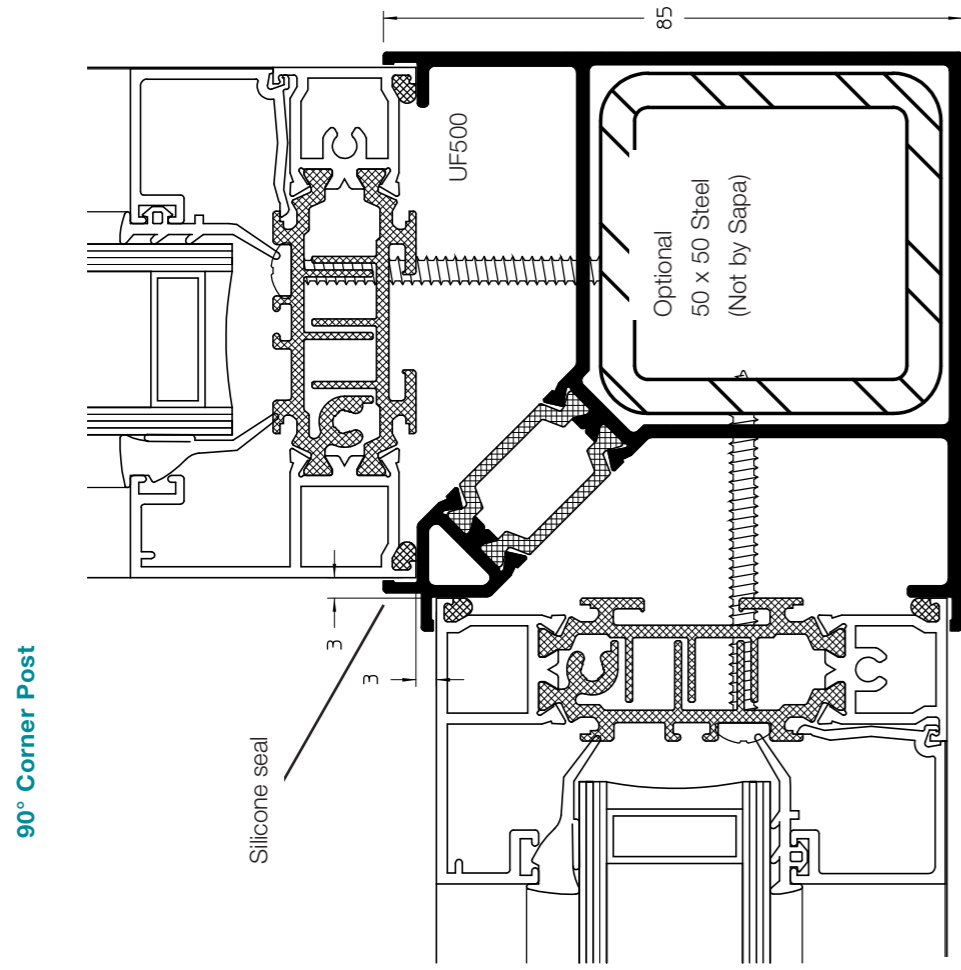

90° Corner Post

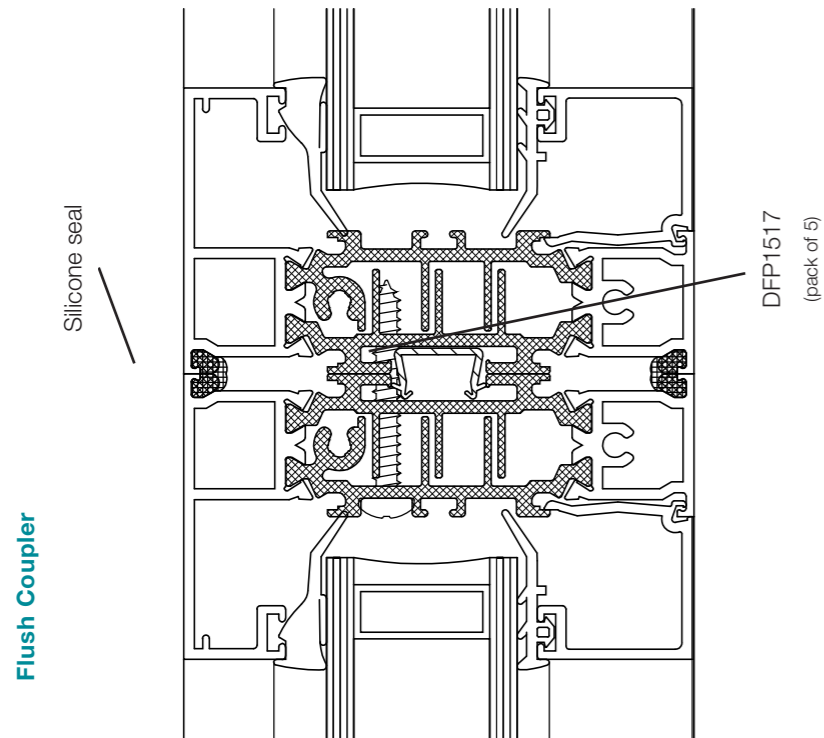

Flush Coupler

Showing outerframe DF1400.
This option is also available for DF1401 outerframe

25mm Heavy Duty Coupler

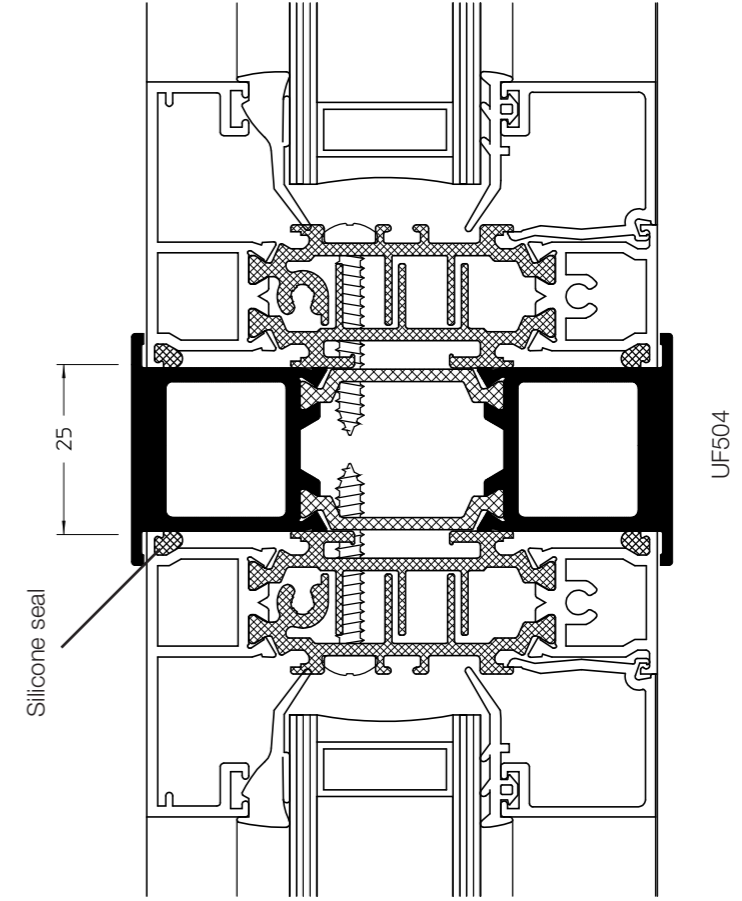

75mm Heavy Duty Coupler

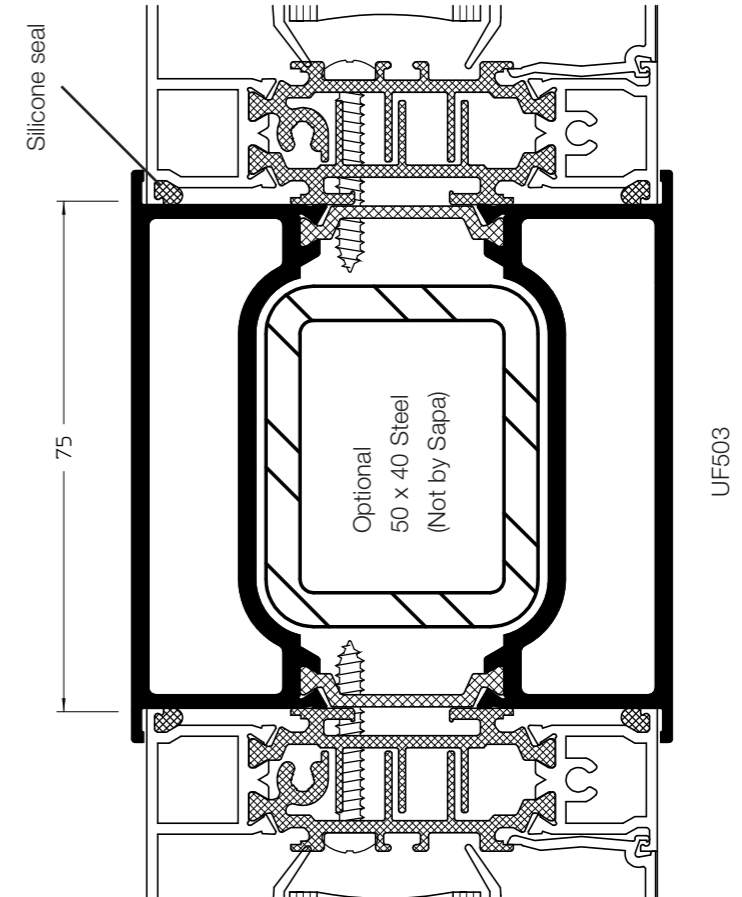

Face Applied Dummy Mullion/Transom

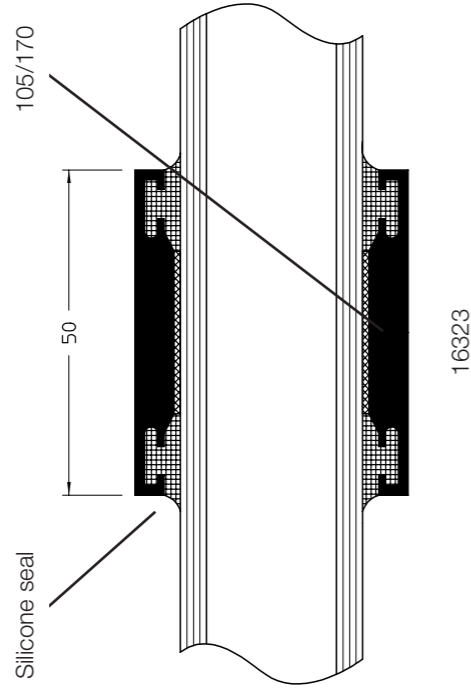

50mm Heavy Duty Coupler

Showing Dualframe 75mm Si Coupled to Dualframe 75mm

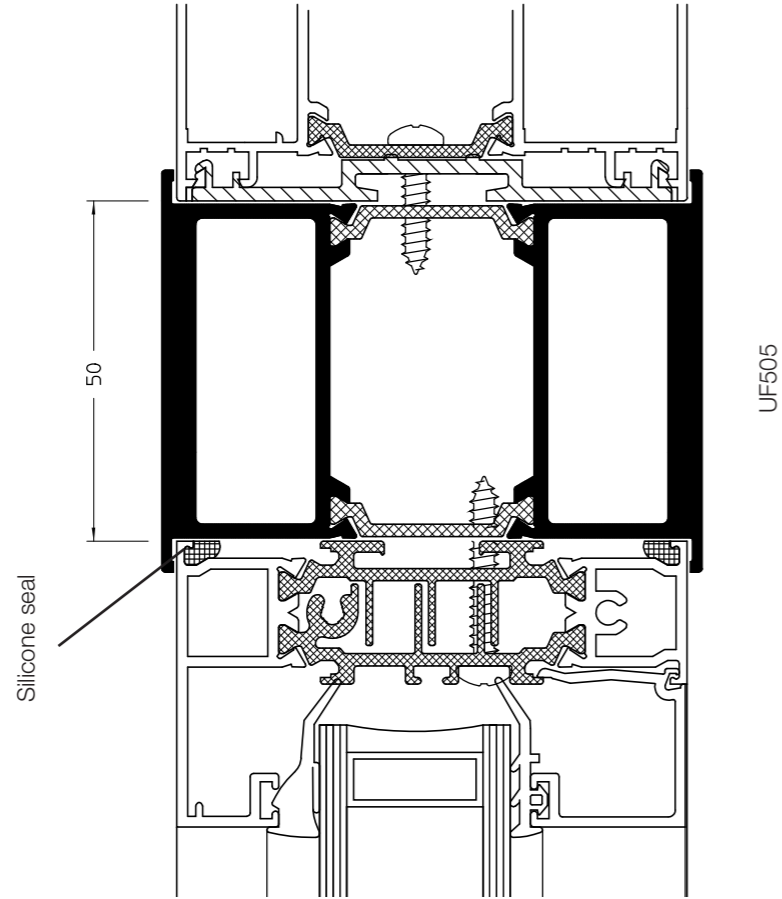

Reverse Rebate Mullion

Showing outerframe DF1400.
This option is also available for DF1401 outerframe.

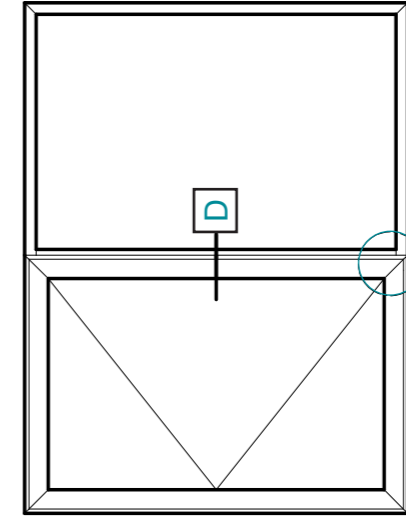
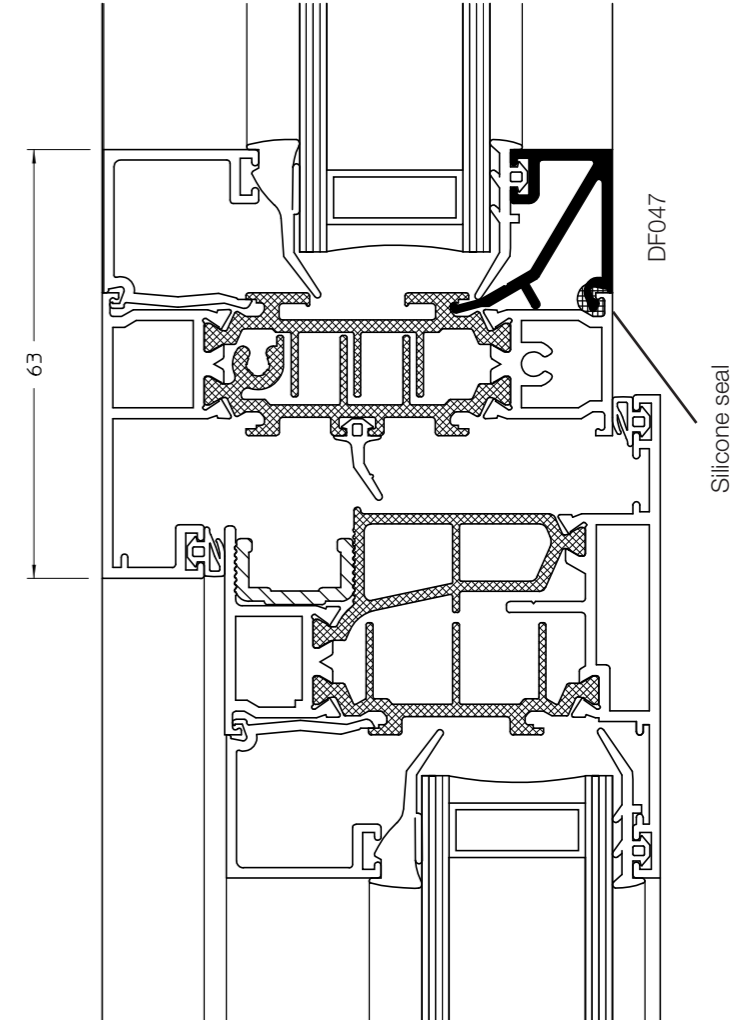

Typical casement window.

This window is manufactured as separate frames, and then joined together.

One frame is a complete rectangular frame of standard construction. The other is goal post shaped.

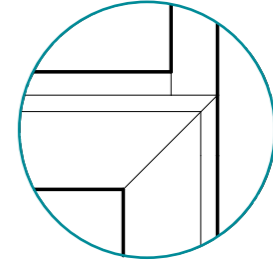

Mullion joint view

Head Vent

Showing optional trickle vent, DF1407 outerframe only.

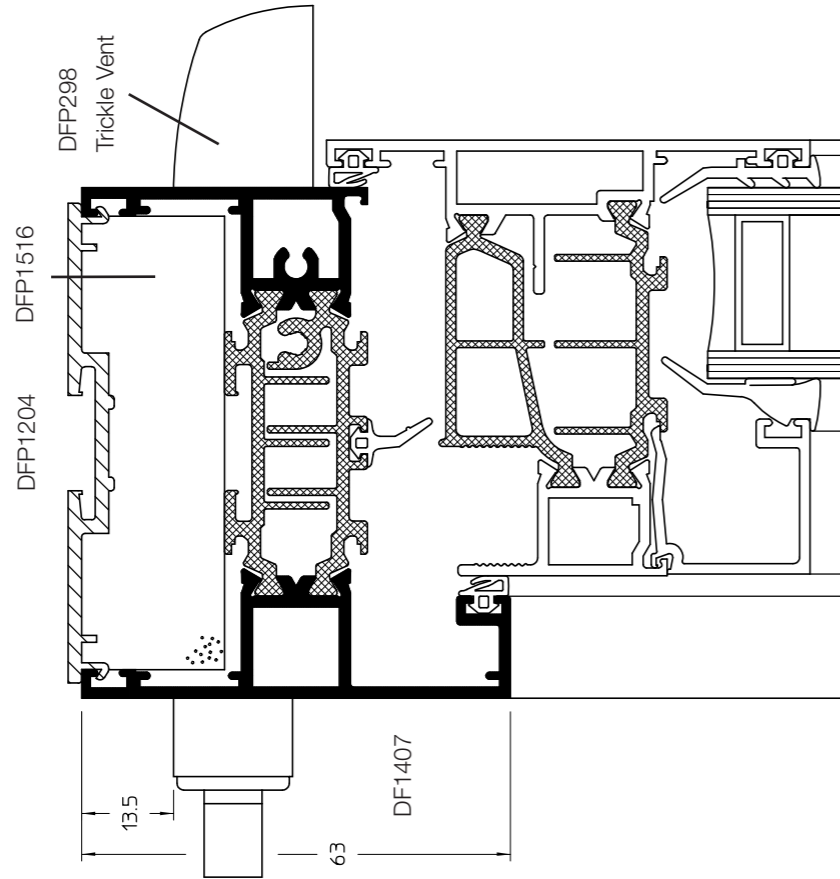

Head Vent Body

Showing optional trickle vent profile, DF1400 frame shown, other frame / vent profile combinations available.

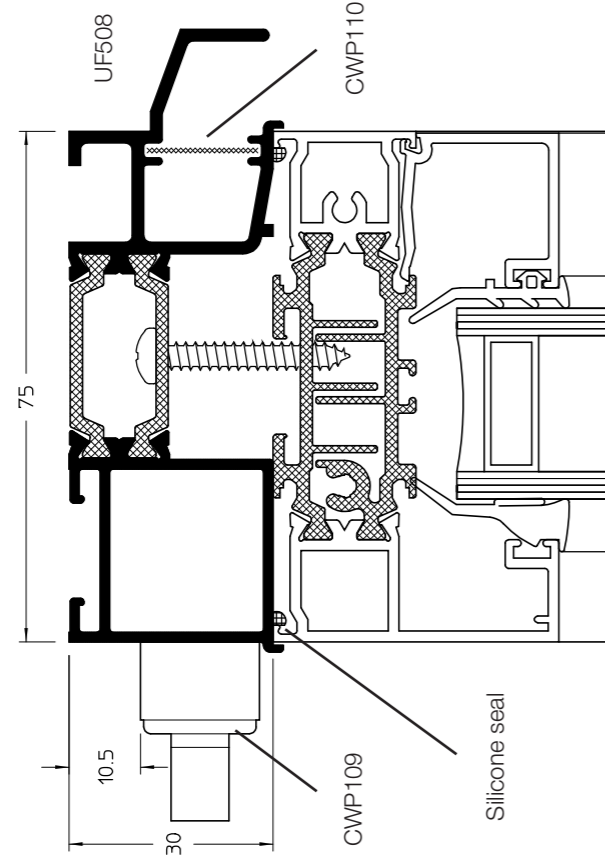

Specialised Range of Profiles

The specialised profile range adds great flexibility when constructing windows where inward and outward facing rebates have to be combined, without the need for coupling sections or dummy frames to fixed lights. These profiles can be used with the standard range of profiles giving even greater scope for construction.

In the example opposite, we have an Si Casement window over an Si TBT window over a glaze-in fixed light, with the centre range of panels being glaze-out, and the end range consisting of a Dualside Window over a glaze-in fixed light.

The frame corners are butt jointed instead of the usual crimping method due to the varying outerframe profiles being used.

The following sectional arrangements highlight an example of how the specialised profiles can be used. Other combinations are possible and the method of construction should be based on consideration of performance, appearance and cost.

The full range of specialised profiles can be found after the sectional details.

Please refer to the specialised section of this manual for machining/assembly.

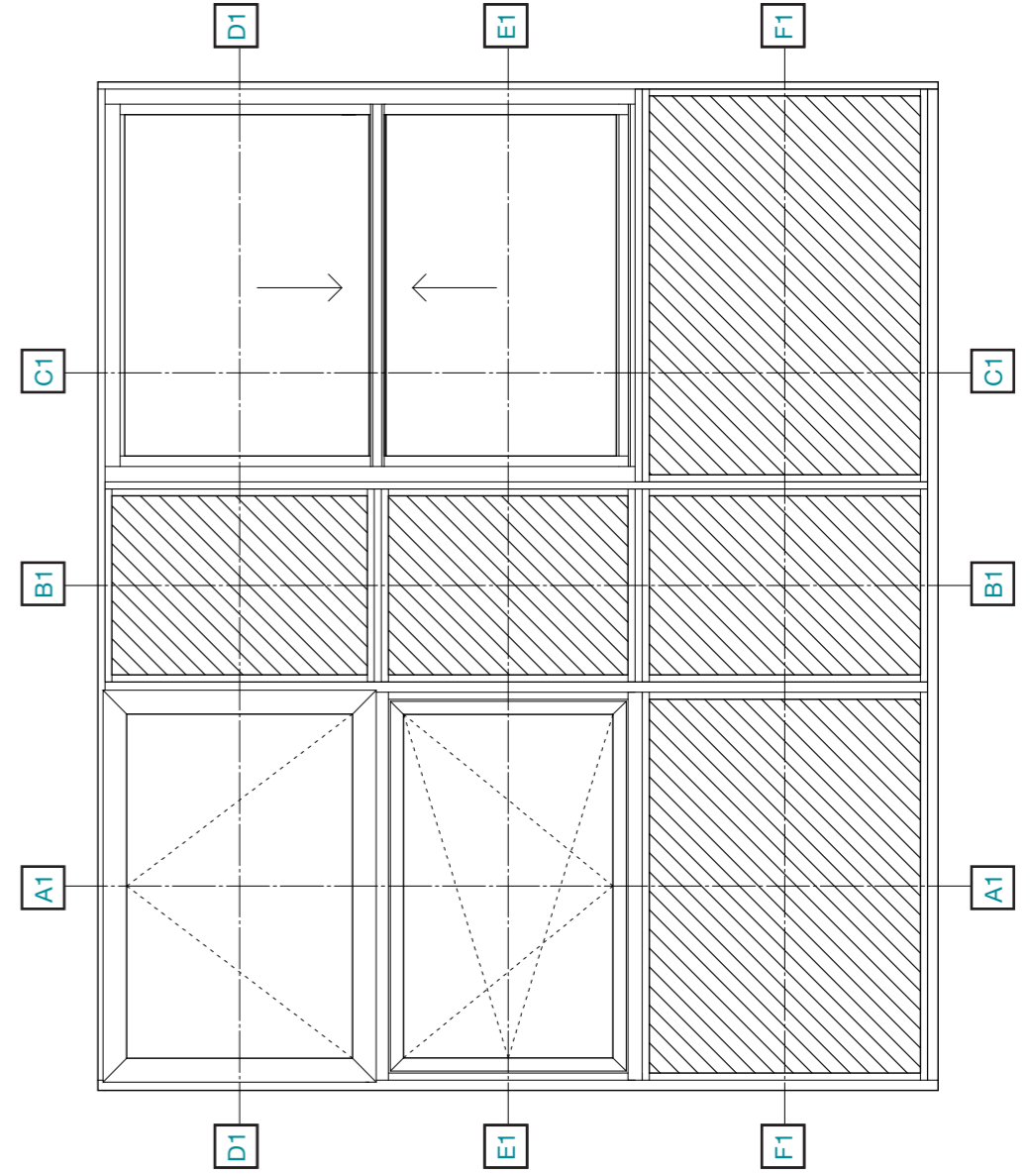

A₁ Specialised Profiles

Notice standard
outerframe profile DF1400
being used as a transom

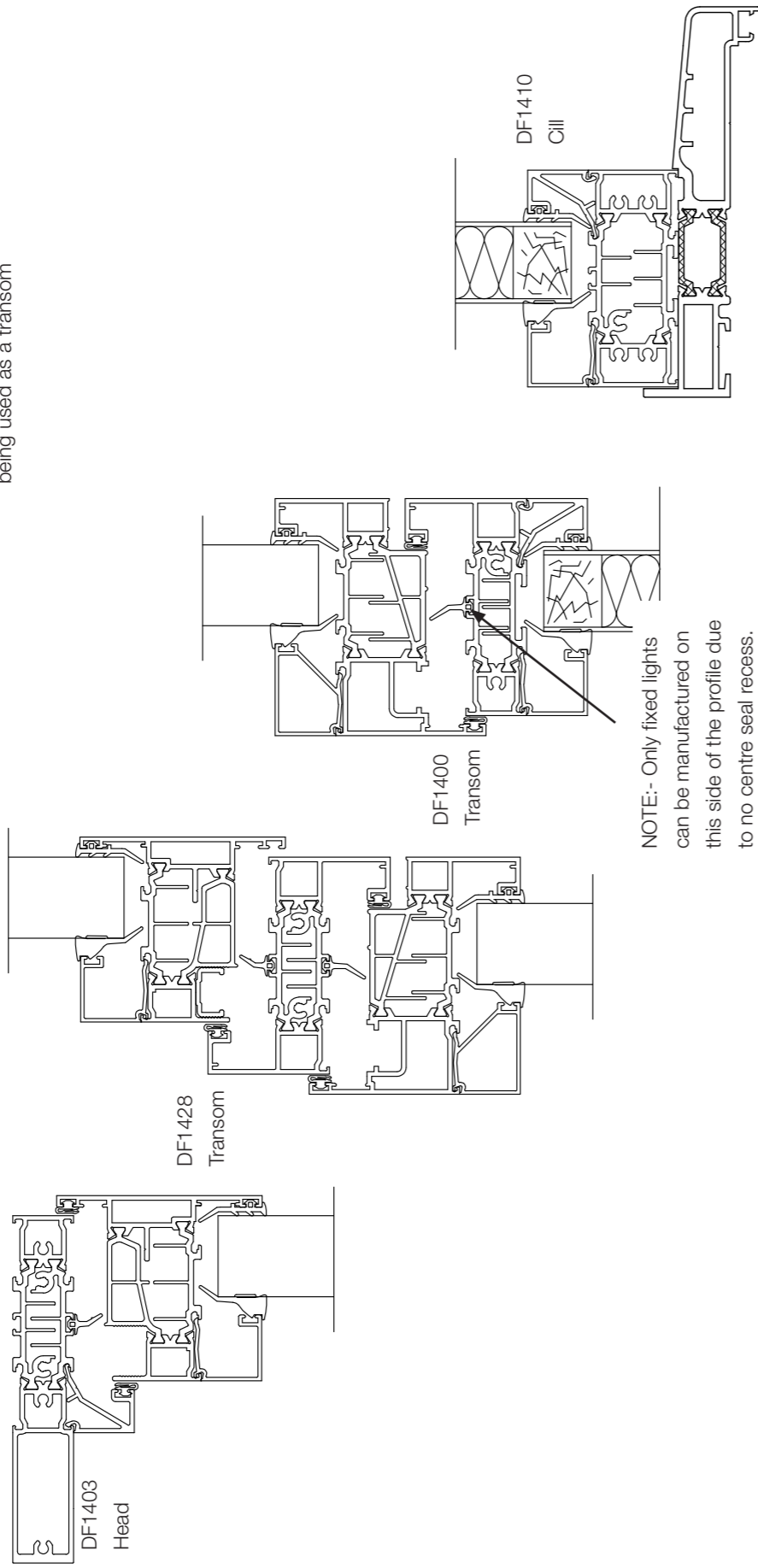

B₁ Specialised Profiles

Notice standard
Mullion/transom profile
being used

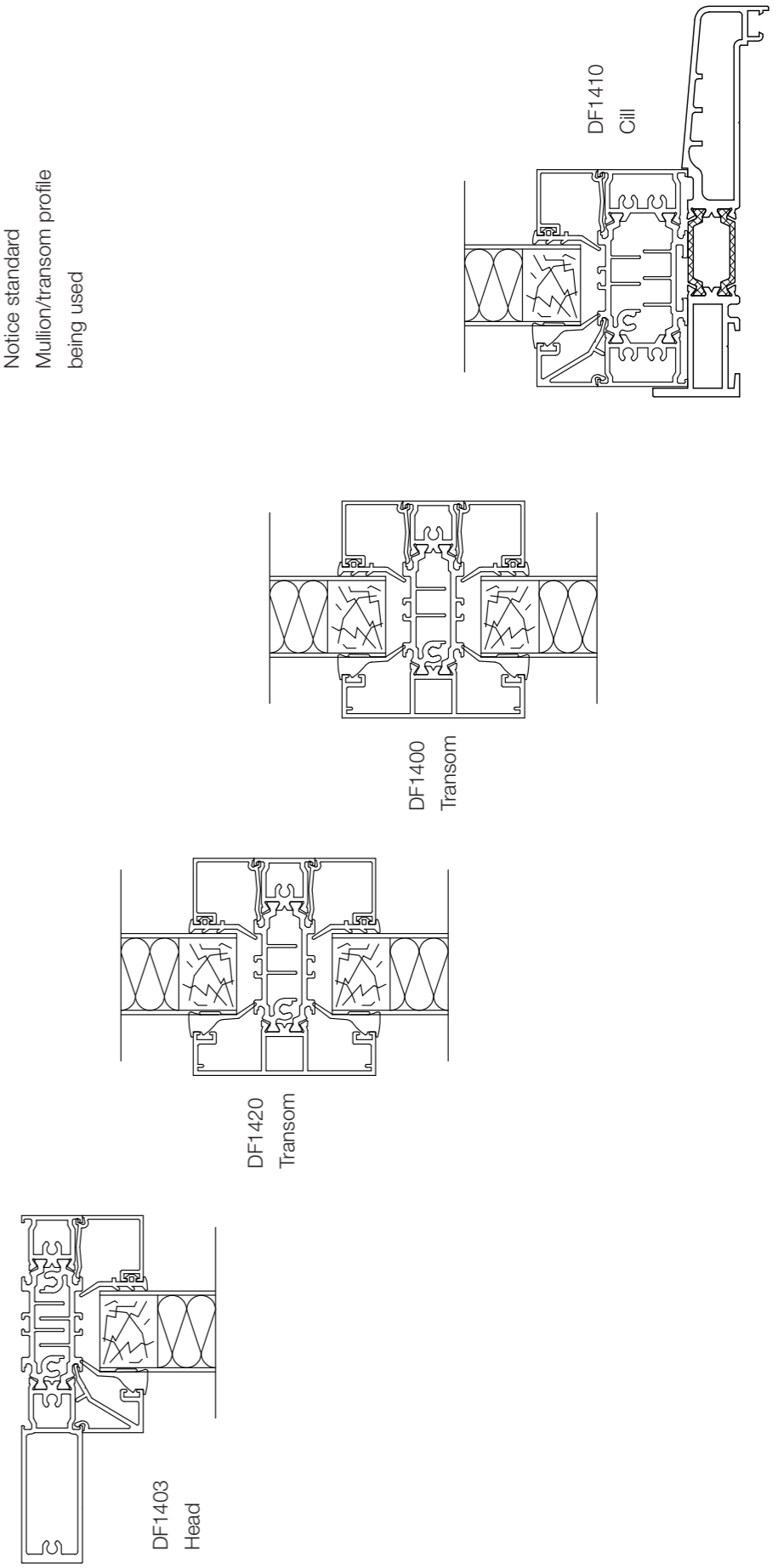



G1 Specialist Profiles

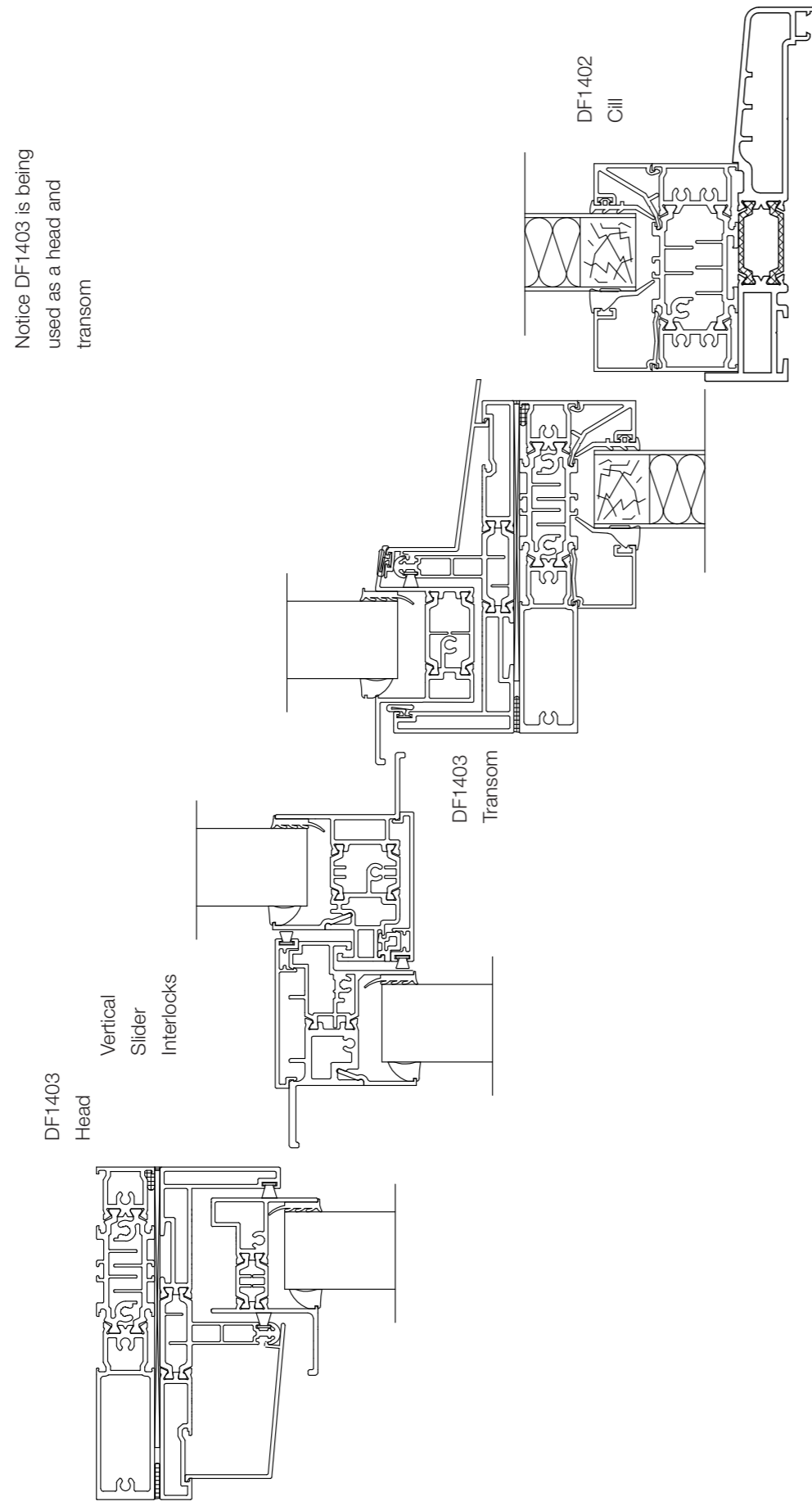

D1 Specialist Profiles

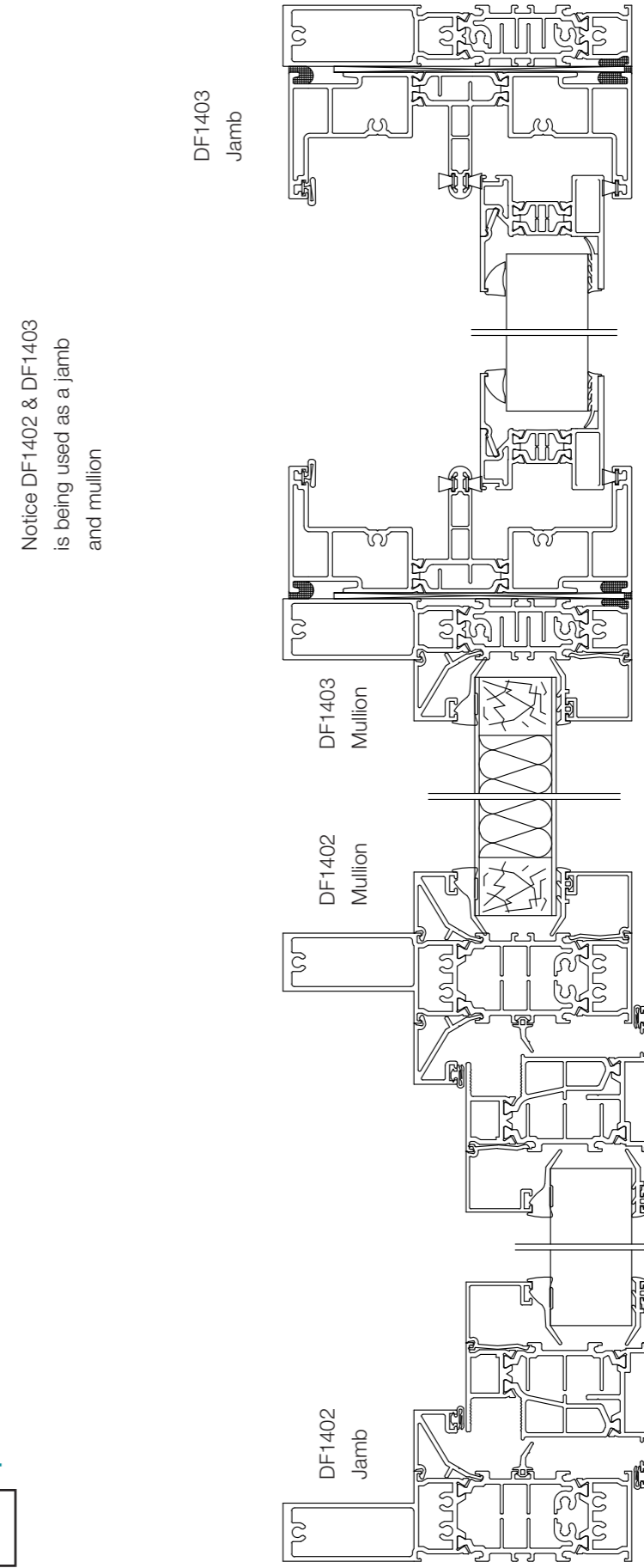

E1 Specialised Profiles

Notice DF1402 & DF1403 is being used as a jamb and mullion

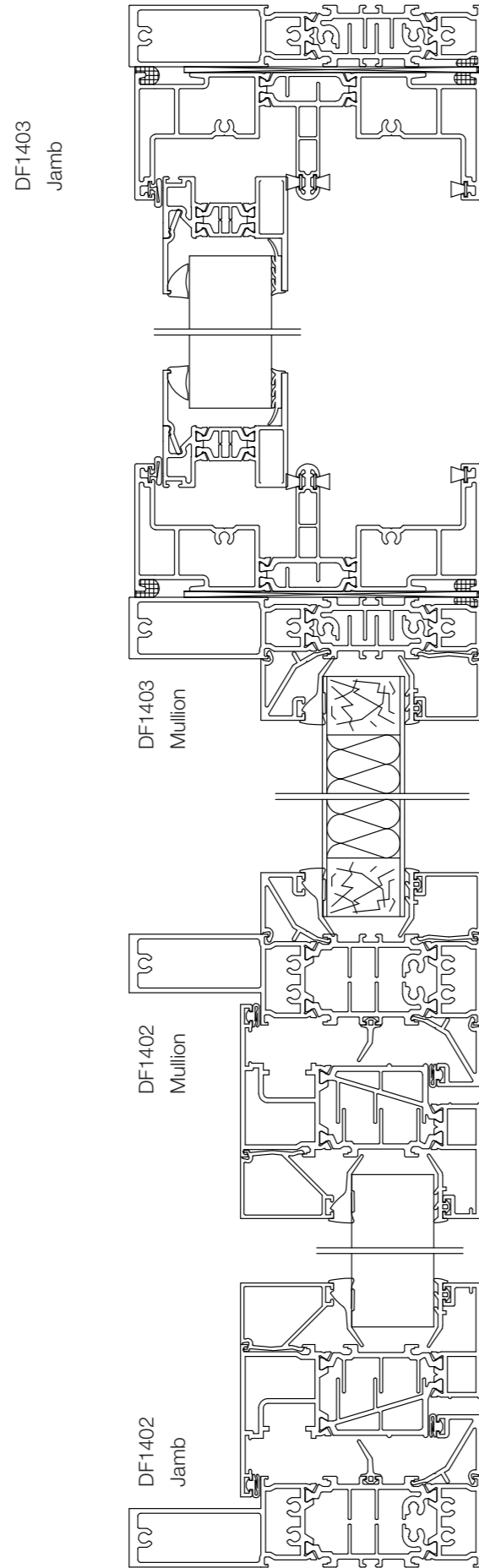

F1 Specialised Profiles

Notice DF1402 & DF1403 is being used as a jamb and mullion

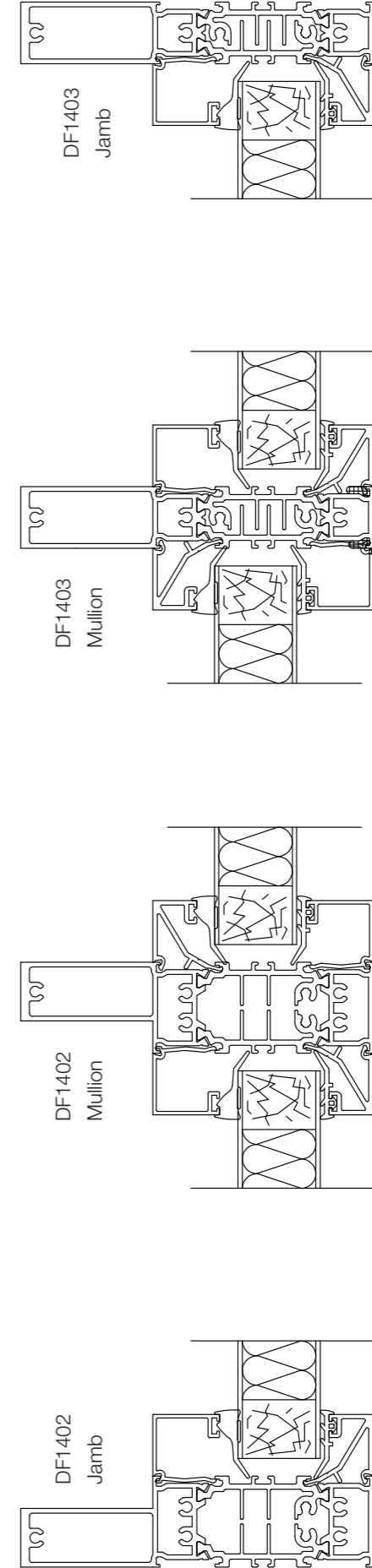

Specialised Profiles Jamb/Vent

Showing universal profile DF1409.
(Reverse rebated for open/glaze out)

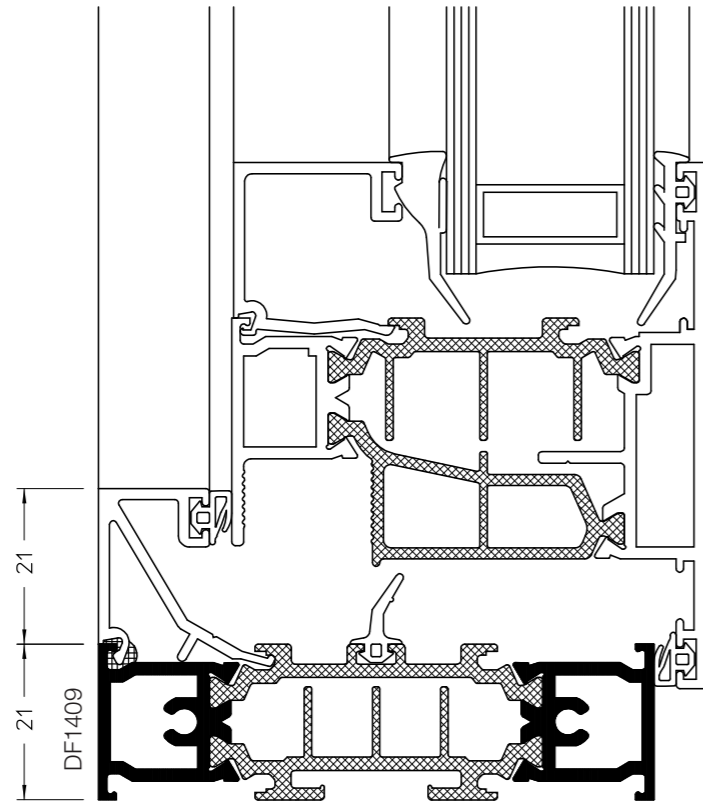

Specialised Profiles HD Jamb/Vent

Showing universal profile DF1410.
(Reverse rebated for open/glaze out)

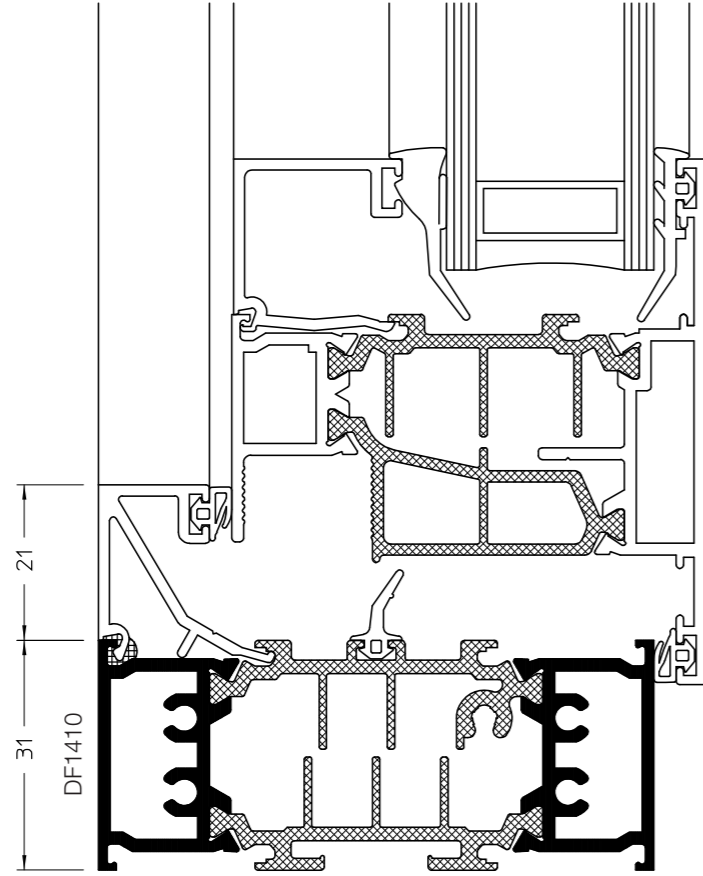

Specialised Profiles Jamb/Vent

Showing universal profile DF1403.
(Reverse rebated for open/glaze out application)

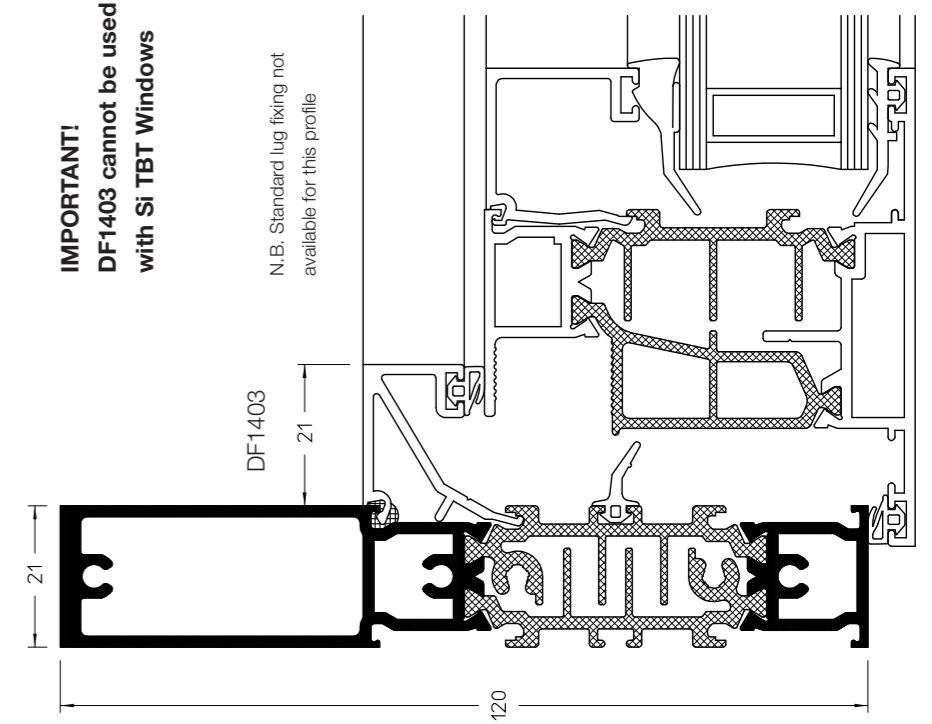

Specialised Profiles HD Jamb/Vent

Showing universal profile DF1402.
(Reverse rebated for open/glaze out application)

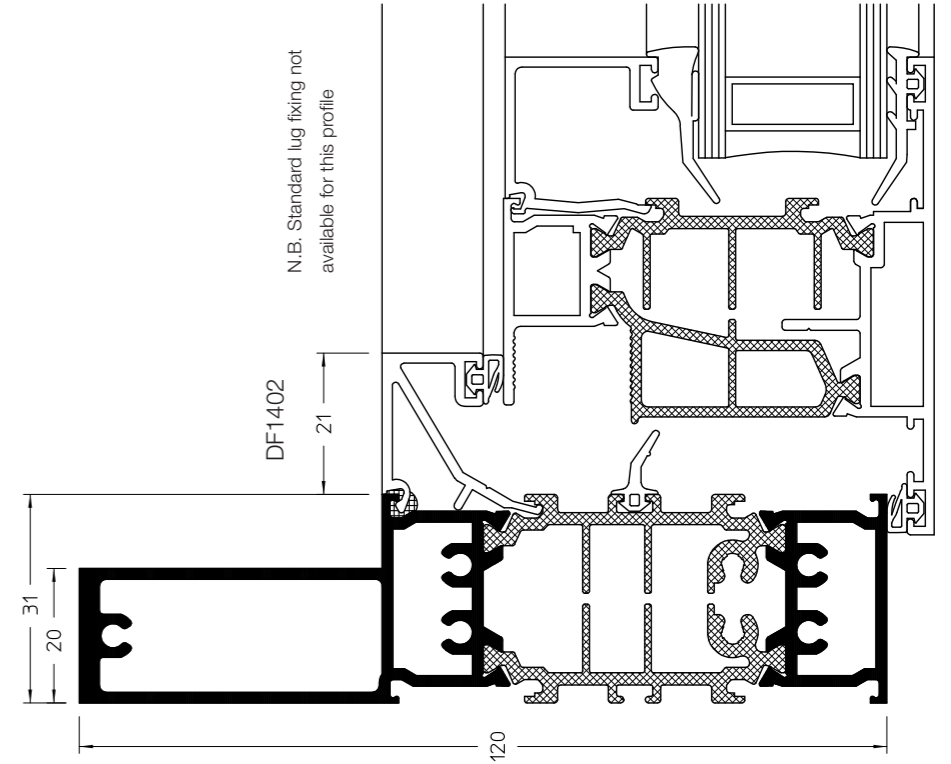

Specialised Profiles Transom/Mullion

Showing universal profile DF1409.
(Reverse rebated for open/glaze out and in applications)

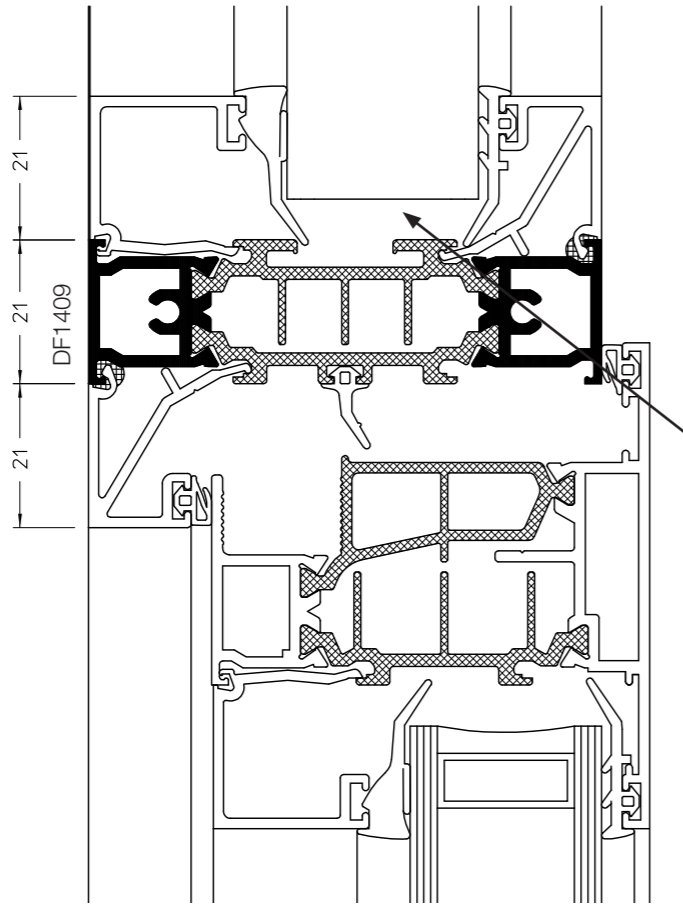

NOTE:- Only fixed lights can be manufactured on this side of the profile due to no centre seal recess.

Specialised Profiles HD Transom/Mullion

Showing universal profile DF1410.
(Reverse rebated for open/glaze out and in applications)

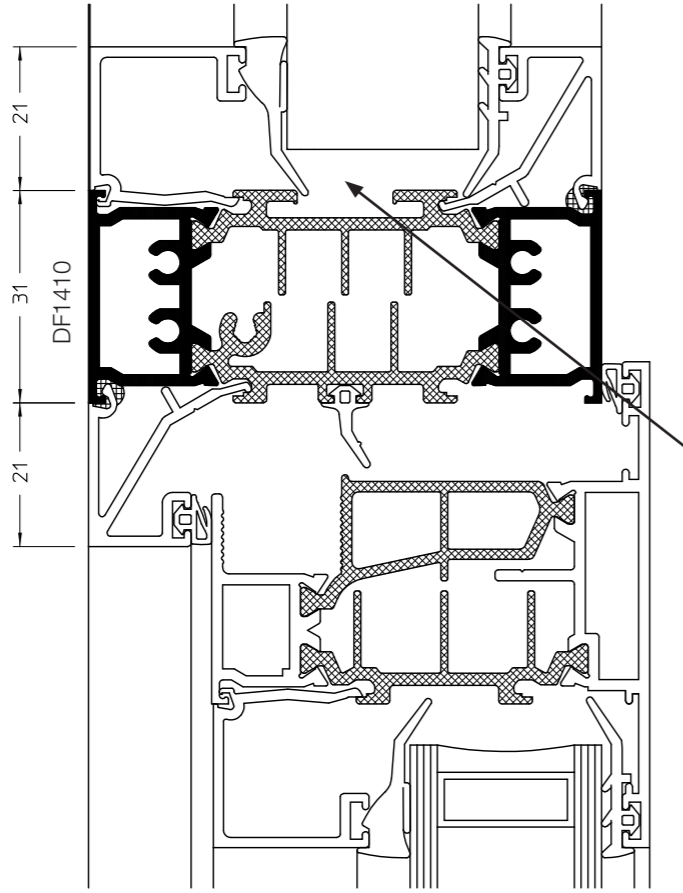

NOTE:- Only fixed lights can be manufactured on this side of the profile due to no centre seal recess.

Specialised Profiles 'Z' Transom/Mullion

Showing universal profile DF1428.

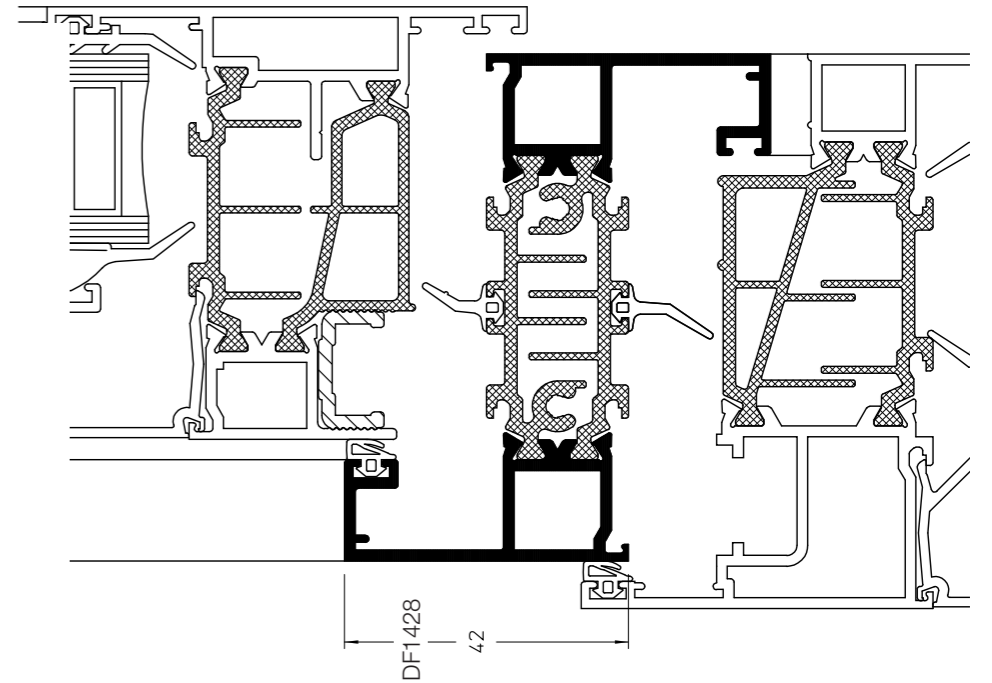

Specialised Profiles 'Z' Transom/Mullion

Showing universal profile DF1429.

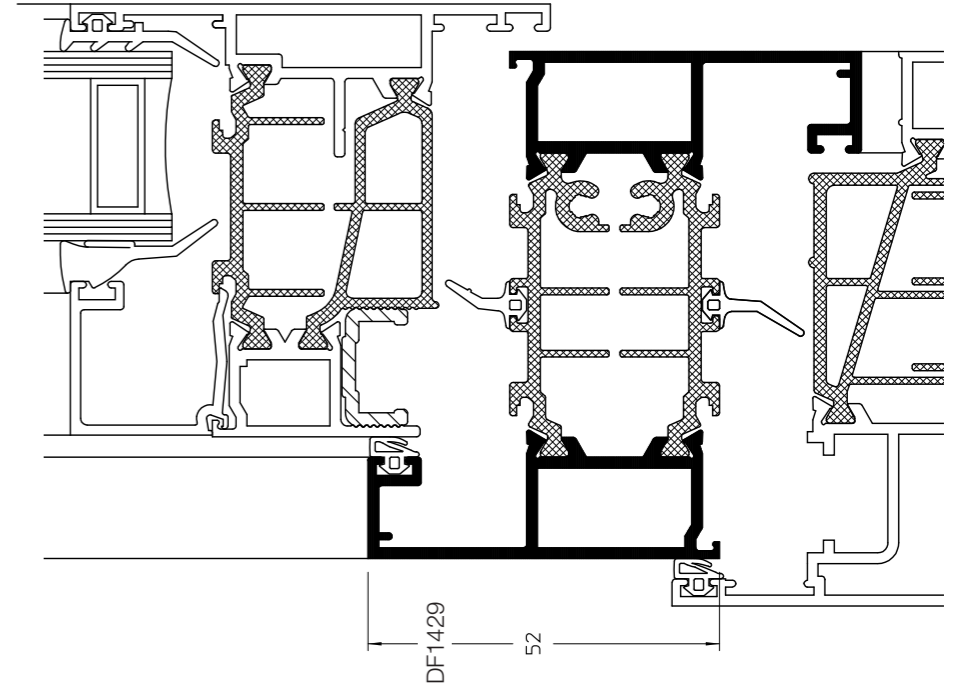

NOTE:- Only fixed lights can be manufactured on this side of the profile due to no centre seal recess.

Our policy is one of continuous development and consequently we reserve the right to vary the products and their performance specification shown in this literature without notice. All products and systems which Sapa supply are supplied subject to Sapa's standard Terms and Conditions of Sale which may vary from time to time.

This Technical Data Sheet is for specification guidance only. It should not be relied on for manufacturing or installation details which must instead be obtained from Sapa Building Systems' Fabrication Manuals. For further assistance please contact one of our Project Consultants by calling the Marketing Team on the number below.

© Sapa Building Systems Limited. This data sheet is issued subject to the condition that it shall not be reproduced without the consent of Sapa Building Systems Limited in writing.

Brochure reference DFC48 0309

Sapa Building Systems Limited

Tewkesbury Business Park, Severn Drive, Tewkesbury, Gloucestershire GL20 8TX
T: 01684 853500 F: 01684 851850
E: info.buildingsystems.uk@sapagroup.com
www.sapabuildingsystems.co.uk

sapa:

buildingsystem

ARCHITECTURAL ALUMINIUM SOLUTIONS